









Overview Page

Job Name:  
MO\_WA09E\_Reroute

Date: 02/09/2023

LEGEND

- |   |  |  |  |  |
|---|--|--|--|--|
|  Aerial Cable      |  Slack Span               |  Overhead Guy |  Mr State = No MR         |  Mr State = MR Resolved |
|  Mr State = PCO-MR |  Mr State = MR Unresolved |  Done = true  |  Mr State = MR Unresolved |  |

SCALE IN FEET



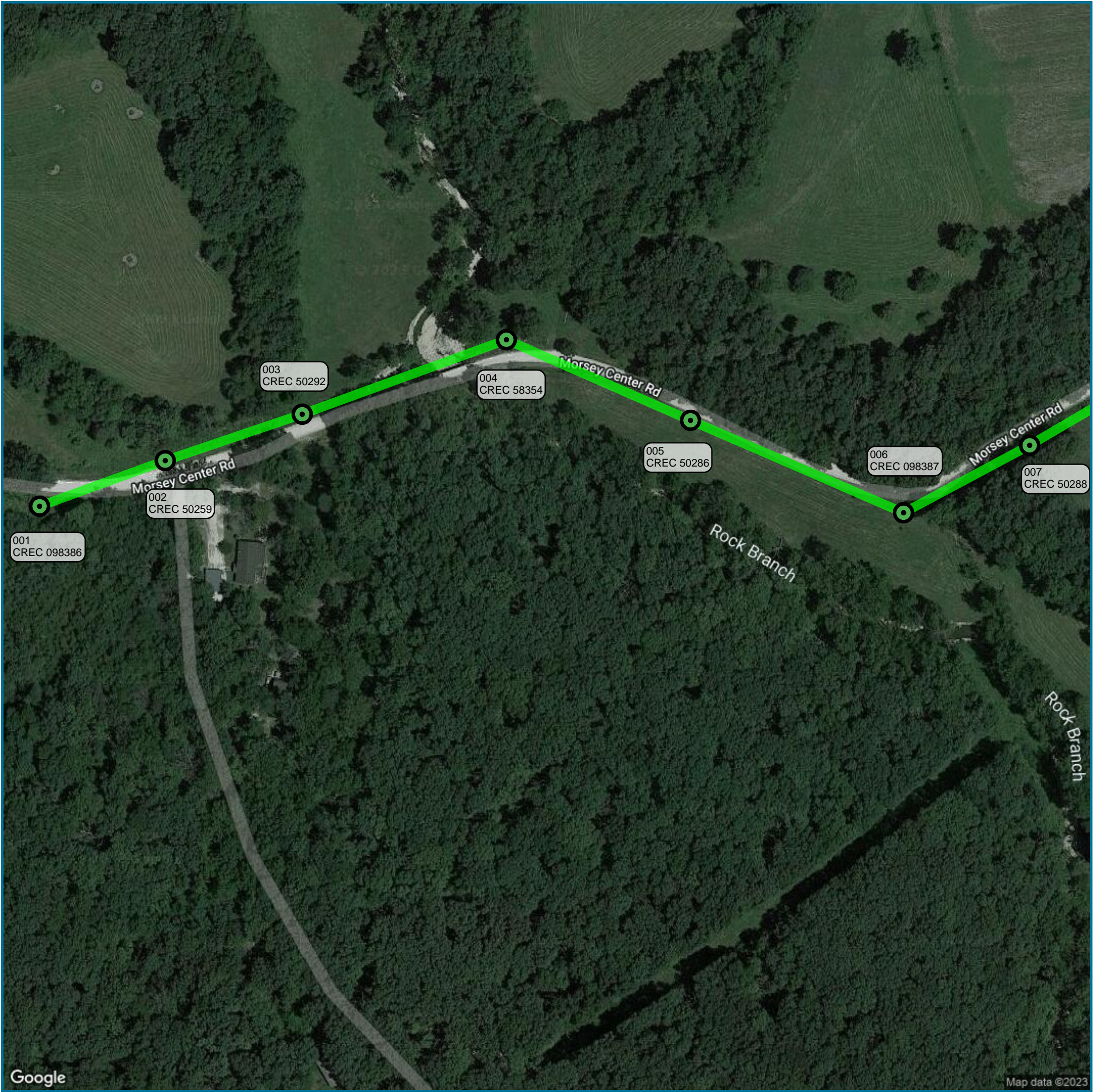

Google Map data ©2023

Page No: 1 of 3

Job Name:  
MO\_WA09E\_Reroute

Date: 02/09/2023

**LEGEND**

Aerial Cable	Slack Span	Overhead Guy	Mr State = No MR	Mr State = MR Resolved
Mr State = PCO-MR	Mr State = MR Unresolved	Done = true	Mr State = MR Unresolved	

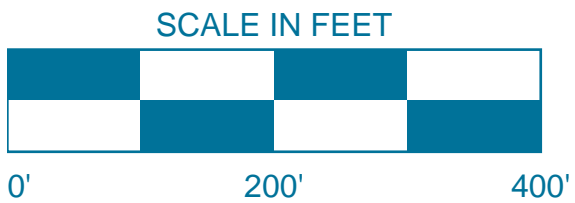











Page No: 2 of 3

Job Name:  
MO\_WA09E\_Reroute

Date: 02/09/2023

LEGEND

- |   |  |  |  |  |
|---|--|--|--|--|
|  Aerial Cable      |  Slack Span               |  Overhead Guy |  Mr State = No MR         |  Mr State = MR Resolved |
|  Mr State = PCO-MR |  Mr State = MR Unresolved |  Done = true  |  Mr State = MR Unresolved |  |

SCALE IN FEET

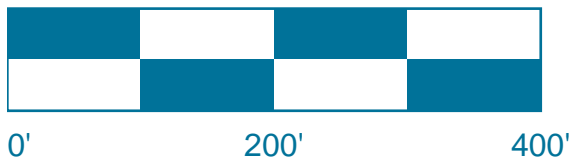

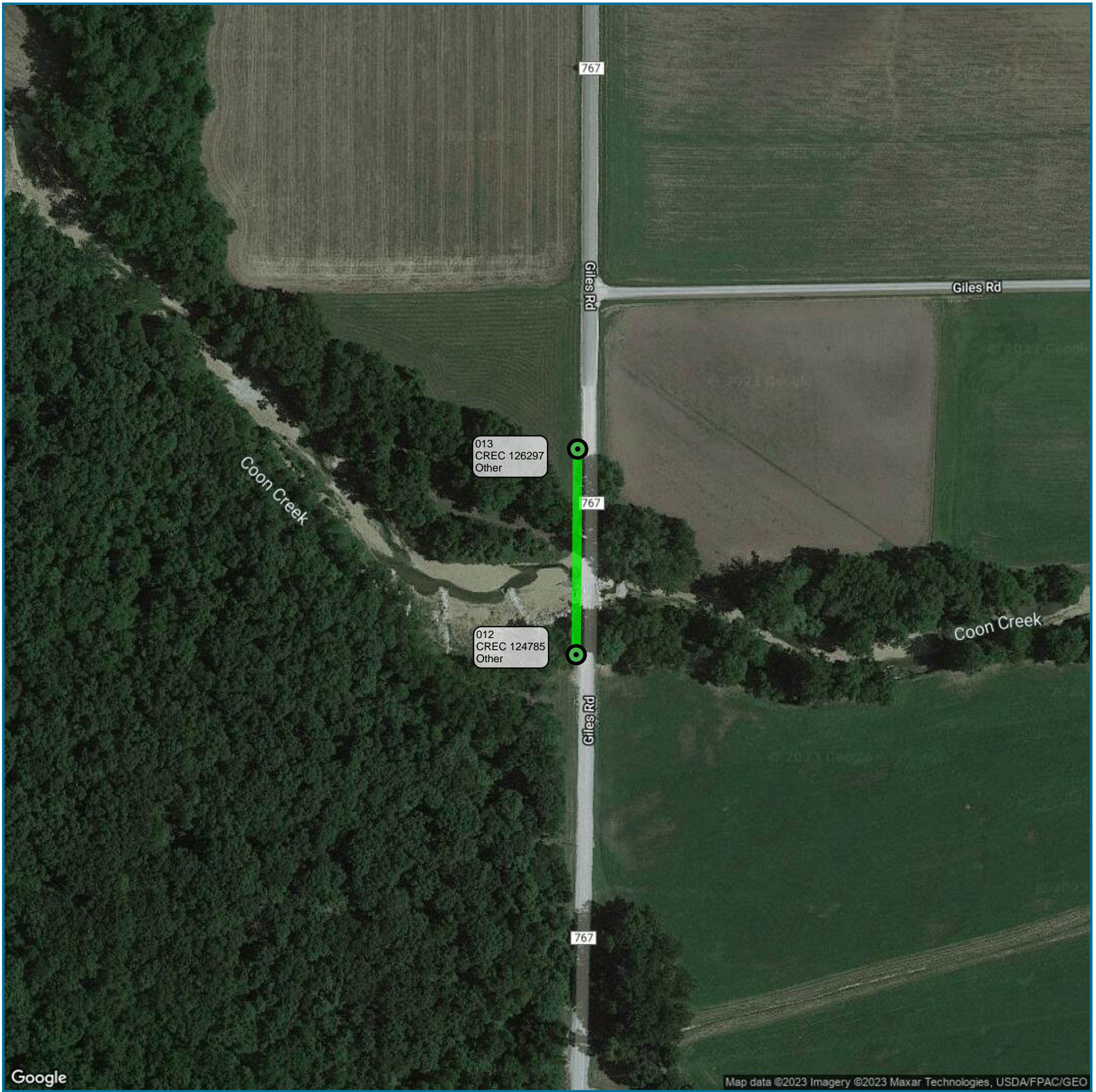

Google

Map data ©2023 Imagery ©2023 Maxar Technologies, USDA/FPAC/GEO

Page No: 3 of 3

Job Name:  
MO\_WA09E\_Reroute

Date: 02/09/2023

LEGEND

 Aerial Cable

 Slack Span

 Overhead Guy

 Mr State = No MR

 Mr State = MR Resolved

 Mr State = PCO-MR

 Mr State = MR Unresolved

 Done = true

 Mr State = MR Unresolved

SCALE IN FEET

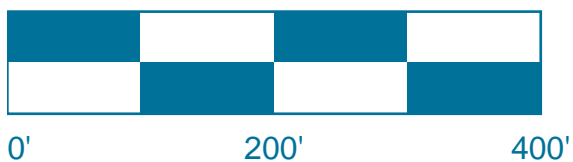





### MO\_WA09E\_Reroute

#### Project Properties

<b>Project Name:</b> MO_WA09E_Reroute	<b>Project Engineer:</b>	<b>General Location:</b>	<b>Client Data File:</b> Cuivre River.client
<b>Address:</b>	<b>Project Date:</b> 02/09/2023	<b>Report Date:</b> 02/09/2023	
<b>Comments:</b>			

### Project Analysis Summary

**Lead: MO\_WA09E\_Reroute Location: U - 001 - 098386**

Layer	Pole Length/Class	Maximum Load %									Pole Strength Remaining	Loading Adjusted by Strength?	Clearance Violations Present?
		Pole	Guy	Anchor	Cross Arm	Insulator	Sidewalk Brace	Foundation	Utility Wire	Communication Wire			
Proposed	50'4	31.26 from stress	94.04 (DownGuy#1)	80.41 (Anchor#1)	No Data	43.87 (Insulator#5)	No Data	No Data	44.18 (Wire#8)	21.06 (ProposedWire#1)	No Data	N	N
Existing	50'4	25.79 from stress	30.84 (Guy#2)	34.2 (Anchor#2)	No Data	42.34 (Insulator#1)	No Data	No Data	44.18 (Wire#8)	No Data	No Data	N	N

**Lead: MO\_WA09E\_Reroute Location: U - 002 - 50259**

Layer	Pole Length/Class	Maximum Load %									Pole Strength Remaining	Loading Adjusted by Strength?	Clearance Violations Present?
		Pole	Guy	Anchor	Cross Arm	Insulator	Sidewalk Brace	Foundation	Utility Wire	Communication Wire			
Proposed	35'5	77.93 from stress	No Data	No Data	13.59 (CrossArm#1)	20.59 (Insulator#5)	No Data	No Data	45.49 (Wire#4)	21.71 (ProposedWire#2)	No Data	N	N
Existing	35'5	62.75 from stress	No Data	No Data	13.59 (CrossArm#1)	10.76 (Insulator#3)	No Data	No Data	45.49 (Wire#8)	No Data	No Data	N	N

**Lead: MO\_WA09E\_Reroute Location: U - 003 - 50292**

Layer	Pole Length/Class	Maximum Load %									Pole Strength Remaining	Loading Adjusted by Strength?	Clearance Violations Present?
		Pole	Guy	Anchor	Cross Arm	Insulator	Sidewalk Brace	Foundation	Utility Wire	Communication Wire			
Proposed	40'4	96.04 from stress	89.45 (Guy#1)	99.18 (Anchor#1)	25.26 (CrossArm#1)	41.88 (Insulator#7)	No Data	No Data	53.04 (Wire#1)	28.57 (ProposedWire#1)	No Data	N	N
Existing	40'4	123.28 from stress	No Data	No Data	25.28 (CrossArm#1)	17.92 (Insulator#6)	No Data	No Data	53.04 (Wire#1)	No Data	No Data	N	N

**Lead: MO\_WA09E\_Reroute Location: U - 004 - 58354**

Layer	Pole Length/Class	Maximum Load %									Pole Strength Remaining	Loading Adjusted by Strength?	Clearance Violations Present?
		Pole	Guy	Anchor	Cross Arm	Insulator	Sidewalk Brace	Foundation	Utility Wire	Communication Wire			
Proposed	50'4	39.18 from stress	63.02 (DownGuy#2)	59.34 (Anchor#3)	No Data	63.87 (Insulator#1)	No Data	No Data	53.04 (Wire#6)	28.57 (ProposedWire#1)	No Data	N	N
Existing	50'4	41.39 from stress	45.3 (Guy#2)	50.23 (Anchor#2)	No Data	63.87 (Insulator#1)	No Data	No Data	53.04 (Wire#6)	No Data	No Data	N	N

**Lead: MO\_WA09E\_Reroute Location: U - 005 - 50286**

Layer	Pole Length/Class	Maximum Load %									Pole Strength Remaining	Loading Adjusted by Strength?	Clearance Violations Present?
		Pole	Guy	Anchor	Cross Arm	Insulator	Sidewalk Brace	Foundation	Utility Wire	Communication Wire			
Proposed	35'5	97.89 from stress	41.76 (Guy#1)	35.71 (Anchor#1)	18.31 (CrossArm#1)	34.2 (Insulator#5)	No Data	No Data	54.72 (Wire#8)	30.93 (ProposedWire#2)	No Data	N	N
Existing	35'5	91.2 from stress	No Data	No Data	18.34 (CrossArm#1)	14.87 (Insulator#3)	No Data	No Data	54.72 (Wire#8)	No Data	No Data	N	N

**Lead: MO\_WA09E\_Reroute Location: U - 006 - 098387**

Layer	Pole Length/Class	Maximum Load %									Pole Strength Remaining	Loading Adjusted by Strength?	Clearance Violations Present?
		Pole	Guy	Anchor	Cross Arm	Insulator	Sidewalk Brace	Foundation	Utility Wire	Communication Wire			
Proposed	50'4	51.69 from stress	98.95 (DownGuy#2)	84.6 (Anchor#2)	No Data	71.34 (Insulator#1)	No Data	No Data	60.65 (Wire#3)	30.93 (ProposedWire#1)	No Data	N	N
Existing	50'4	58.1 from stress	35.21 (Guy#3)	39.04 (Anchor#3)	No Data	71.34 (Insulator#1)	No Data	No Data	60.65 (Wire#10)	No Data	No Data	N	N

**Lead: MO\_WA09E\_Reroute Location: U - 007 - 50288**

Layer	Pole Length/Class	Maximum Load %									Pole Strength Remaining	Loading Adjusted by Strength?	Clearance Violations Present?
		Pole	Guy	Anchor	Cross Arm	Insulator	Sidewalk Brace	Foundation	Utility Wire	Communication Wire			
Proposed	35'5	99.32 from stress	No Data	No Data	15.04 (CrossArm#1)	24.58 (Insulator#5)	No Data	No Data	46.77 (Wire#8)	23.98 (ProposedWire#2)	No Data	N	N
Existing	35'5	78.45 from stress	No Data	No Data	15.04 (CrossArm#1)	12.32 (Insulator#3)	No Data	No Data	46.77 (Wire#8)	No Data	No Data	N	N

**Lead: MO\_WA09E\_Reroute Location: U - 008 - 50260**

Layer	Pole Length/Class	Maximum Load %									Pole Strength Remaining	Loading Adjusted by Strength?	Clearance Violations Present?
		Pole	Guy	Anchor	Cross Arm	Insulator	Sidewalk Brace	Foundation	Utility Wire	Communication Wire			
Proposed	35'5	72.68 from stress	No Data	No Data	14.52 (CrossArm#1)	23.7 (Insulator#5)	No Data	No Data	47.9 (Wire#8)	24.52 (ProposedWire#2)	No Data	N	N
Existing	35'5	58.66 from stress	No Data	No Data	14.53 (CrossArm#1)	12.04 (Insulator#3)	No Data	No Data	47.9 (Wire#8)	No Data	No Data	N	N



Lead: MO\_WA09E\_Reroute Location: U - 009 - 097730

Layer	Pole Length/Class	Maximum Load %									Pole Strength Remaining	Loading Adjusted by Strength?	Clearance Violations Present?
		Pole	Guy	Anchor	Cross Arm	Insulator	Sidewalk Brace	Foundation	Utility Wire	Communication Wire			
Proposed	35/4	38.32 from stress	35.56 (SpanGuy#1)	No Data	12.43 (CrossArm#1)	69.57 (Insulator#5)	No Data	No Data	47.9 (Wire#1)	30.27 (ProposedWire#2)	No Data	N	N
Existing	35/4	35.81 from stress	37.52 (SpanGuy#1)	No Data	12.44 (CrossArm#1)	41.14 (Insulator#4)	No Data	No Data	47.9 (Wire#1)	No Data	No Data	N	N

Lead: MO\_WA09E\_Reroute Location: U - 010 - 50291

Layer	Pole Length/Class	Maximum Load %									Pole Strength Remaining	Loading Adjusted by Strength?	Clearance Violations Present?
		Pole	Guy	Anchor	Cross Arm	Insulator	Sidewalk Brace	Foundation	Utility Wire	Communication Wire			
Proposed	30/4	29.3 from stress	75.66 (DownGuy#1)	64.69 (Anchor#1)	No Data	No Data	No Data	No Data	No Data	30.27 (ProposedWire#1)	No Data	N	N
Existing	30/4	8.14 from stress	0.76 (SpanGuy#1)	No Data	No Data	No Data	No Data	No Data	No Data	No Data	No Data	N	N

Lead: MO\_WA09E\_Reroute Location: U - 011 - 098351

Layer	Pole Length/Class	Maximum Load %									Pole Strength Remaining	Loading Adjusted by Strength?	Clearance Violations Present?
		Pole	Guy	Anchor	Cross Arm	Insulator	Sidewalk Brace	Foundation	Utility Wire	Communication Wire			
Proposed	40/4	73.9 from stress	No Data	No Data	16.64 (CrossArm#1)	25.18 (Insulator#7)	No Data	No Data	46.83 (Wire#3)	23.96 (ProposedWire#1)	No Data	N	Y
Existing	40/4	60.22 from stress	No Data	No Data	19.36 (CrossArm#1)	13.87 (Insulator#3)	No Data	No Data	46.83 (Wire#7)	No Data	No Data	N	Y

Lead: MO\_WA09E\_Reroute Location: U - 012 - 50270

Layer	Pole Length/Class	Maximum Load %									Pole Strength Remaining	Loading Adjusted by Strength?	Clearance Violations Present?
		Pole	Guy	Anchor	Cross Arm	Insulator	Sidewalk Brace	Foundation	Utility Wire	Communication Wire			
Proposed	35/5	73.42 from stress	47.69 (DownGuy#1)	40.78 (Anchor#1)	25.77 (CrossArm#1)	45.65 (Insulator#5)	No Data	No Data	53.32 (Wire#8)	21.91 (ProposedWire#1)	No Data	N	N
Existing	35/5	123.15 from stress	No Data	No Data	24.24 (CrossArm#1)	17.92 (Insulator#3)	No Data	No Data	53.32 (Wire#8)	No Data	No Data	N	N

Lead: MO\_WA09E\_Reroute Location: U - 013 - 124785

Layer	Pole Length/Class	Maximum Load %									Pole Strength Remaining	Loading Adjusted by Strength?	Clearance Violations Present?
		Pole	Guy	Anchor	Cross Arm	Insulator	Sidewalk Brace	Foundation	Utility Wire	Communication Wire			
Proposed	40/4	44.65 from stress	97.02 (DownGuy#1)	82.95 (Anchor#1)	No Data	58.66 (Insulator#3)	No Data	No Data	56.4 (Wire#4)	28.15 (ProposedWire#1)	No Data	N	N
Existing	40/4	29.15 from stress	No Data	No Data	No Data	13.6 (Insulator#1)	No Data	No Data	56.4 (Wire#4)	No Data	No Data	N	N

Lead: MO\_WA09E\_Reroute Location: U - 014 - 126297

Layer	Pole Length/Class	Maximum Load %									Pole Strength Remaining	Loading Adjusted by Strength?	Clearance Violations Present?
		Pole	Guy	Anchor	Cross Arm	Insulator	Sidewalk Brace	Foundation	Utility Wire	Communication Wire			
Proposed	40/4	36.33 from stress	99.98 (DownGuy#1)	85.48 (Anchor#1)	No Data	58.66 (Insulator#3)	No Data	No Data	56.4 (Wire#3)	28.15 (ProposedWire#1)	No Data	N	N
Existing	40/4	40.42 from stress	No Data	No Data	No Data	15.55 (Insulator#1)	No Data	No Data	56.4 (Wire#3)	No Data	No Data	N	N



Measured: Proposed

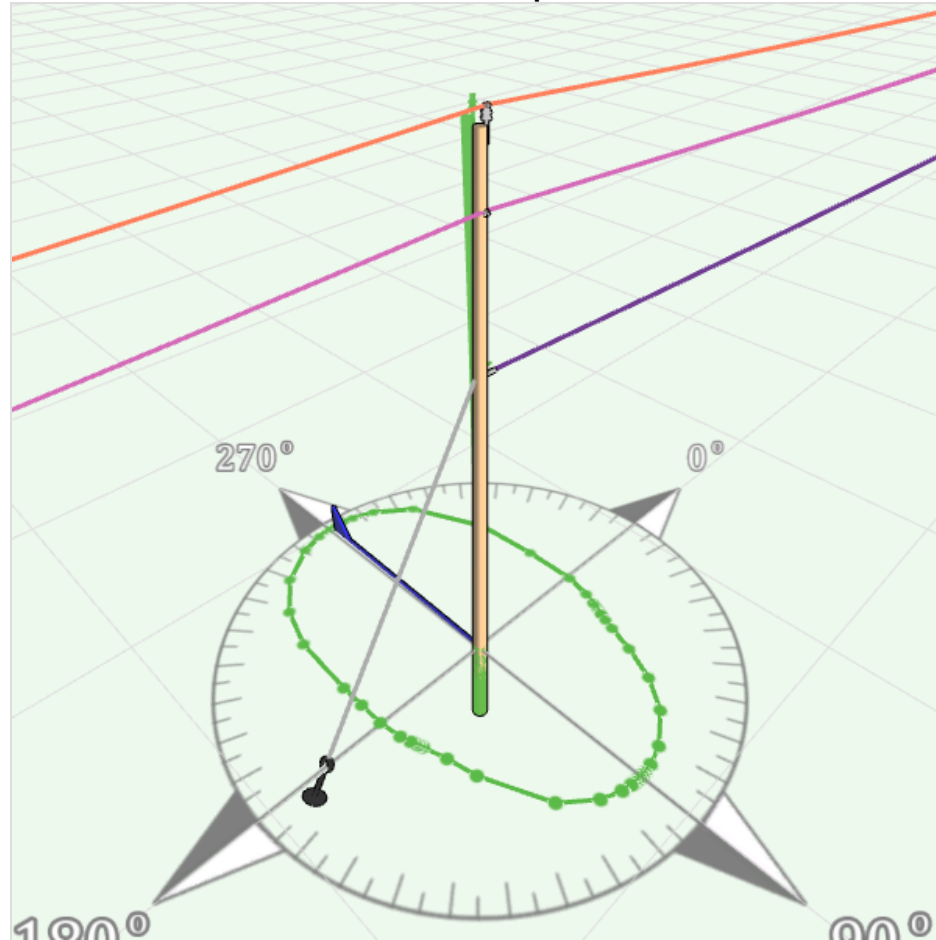

**Design Properties**

**Owner:** Unset Com Owner  
**Species:** Southern Pine  
**Length:** 40'  
**Class:** 4  
**AGL:** 33' 1"  
**GLC:** 33 1/4"  
**Foundation:** None  
**Ground Water Level:** None  
**Lean Angle:** 0 °  
**Lean Direction:** 0 °  
**Capacity Adjustment:** 100%  
**Effective Allowable Stress:** 8000 lb/in²  
**GPS Location:** Undefined.  
**Map Location:** 38.94577862728448 , -91.07688102775653

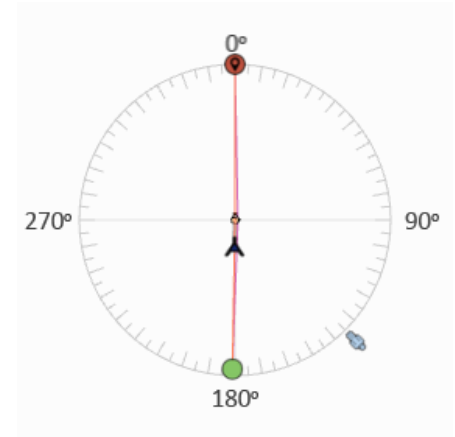
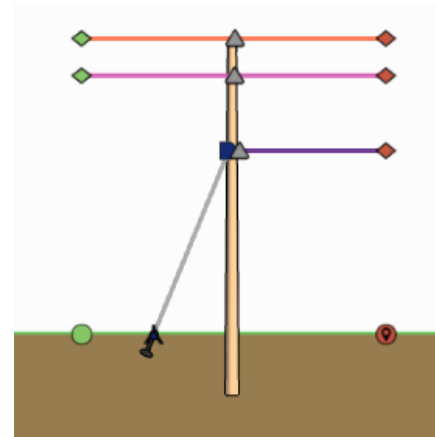

**Design Warnings**

Type	Description
Analysis Near Capacity	1/4" EHS [21' 0"] loading for Heavy Grade C - 97.02 %

**Load Case Properties**

	Heavy Grade C (Governing Case)	Extreme Wind
LoadCase Type	NESC 2012 Heavy	NESC Extreme Wind 2012
Construction Grade	C	B
Construction Type	New	New
Temperature	0 °F	60 °F
Wind Pressure	4 lb/ft²	90 mph
Ice Thickness	0.5"	0"
Wind	Sweep	Sweep
Wind Direction	0 °	0 °
Wind Increment	1 °	1 °
Analysis Method	Basic (Direct Stiffness)	Basic (Direct Stiffness)
Load Percentage Allowed	100%	100%
Average Length on Main Span	No	No
Displacement Based Load Changes	None	None
Analyze Ground Line Only	No	No
Analyze with Buckling Case	No	No
Analyze with Deflection Case	No	No
Analyze with Strength Results	No	No
Custom	No	No

**Analysis Results**

**Loading**

Component	Heavy Grade C (Governing Case)			Extreme Wind			Client File Maximum Rating
	Max %	Load (Applied / Allowable)	Wind Direction	Max %	Load (Applied / Allowable)	Wind Direction	
Pole - Stress	44.65 from stress	3036 lb/in² / 6800 lb/in²	271 °	17.57 from stress	1054 lb/in² / 6000 lb/in²	278 °	8000 lb/in²
3" Spool Bolt [29' 7"] (Insulator#1) - Force	13.6	408 lbf / 3000 lbf	270 °	1.09	33 lbf / 3000 lbf	271 °	3000 lbf
24.9 kV Pin Type Insulator (Pole Top) [32' 3"] (Insulator#2) - Force	8.15	408 lbf / 5000 lbf	270 °	0.65	33 lbf / 5000 lbf	270 °	5000 lbf
Comm D/E Bolt [21' 0"] (Insulator#3) - Force	58.66	4106 lbf / 7000 lbf	90 °	18.16	1272 lbf / 7000 lbf	315 °	7000 lbf
Proposed Fiber 1", Full (ProposedWire#1) - Tension	28.15	3153 lbf / 6720 lbf	N/A	N/A	N/A	N/A	11200 lbf
6 Copperweld Type A, Full (Wire#4) - Tension	56.4	1458 lbf / 1551 lbf	N/A	N/A	N/A	N/A	2585 lbf
1/4" EHS [21' 0"] (DownGuy#1) - Force	97.02	5806 lbf / 5985 lbf	77 °	43.57	2608 lbf / 5985 lbf	1 °	6650 lbf
Proposed Anchor [12' 0", 181 "] (Anchor#1) - Force	82.95	5806 lbf / 7000 lbf	77 °	37.25	2608 lbf / 7000 lbf	1 °	7000 lbf

### Pole Analysis Charts for Governing Load Case: Heavy Grade C

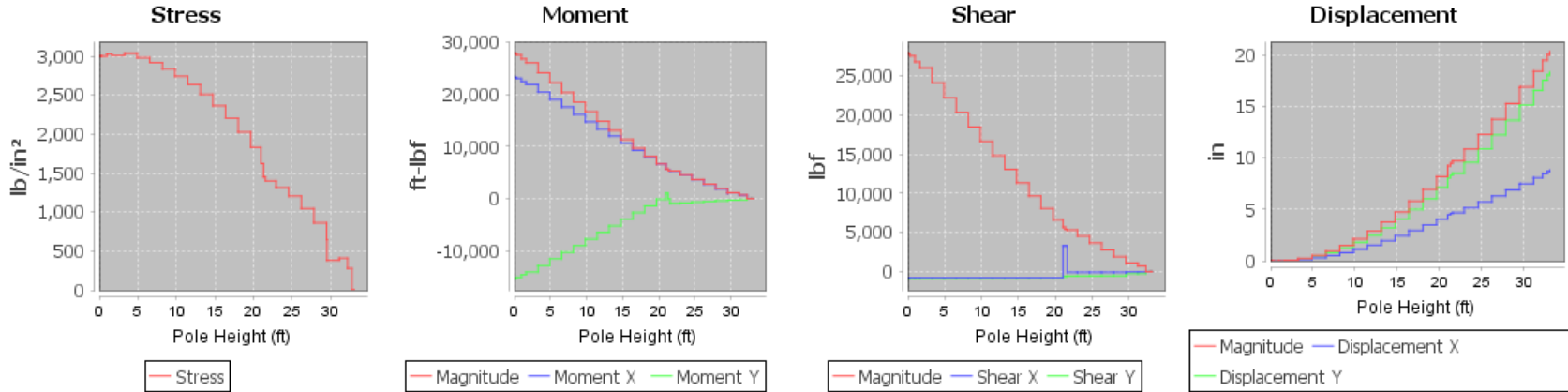

### Pole Static Analysis

#### Heavy Grade C

Heights	Stress %	Stress (lb/in²)	Moment (ft-lbf)			Force (lbf)				Displacement (in)		
			X	Y	Magnitude	X	Y	Shear Magnitude	Axial	X	Y	Magnitude
0' 0"	44.05	2995	23376	-15385	27985	-775	-906	1193	7937	0	0	0
0' 1"	44.17	3004	23317	-15334	27907	-775	-906	1192	7933	0	0	0
0' 2"	44.17	3004	23198	-15232	27752	-775	-905	1191	7927	0	0	0
0' 4"	44.11	3000	23079	-15131	27597	-775	-902	1190	7909	0	0	0
1' 0"	44.48	3025	22487	-14622	26823	-775	-898	1186	7880	0	0	0
1' 8"	44.24	3008	21898	-14113	26052	-775	-891	1181	7831	0	0	0
3' 3"	44.65	3036	20435	-12842	24136	-775	-882	1174	7762	0	0	0
4' 11"	43.82	2980	18989	-11571	22237	-775	-872	1166	7696	0	0	1
6' 7"	42.89	2916	17558	-10301	20357	-774	-863	1159	7633	1	1	1
8' 2"	41.71	2836	16143	-9031	18497	-774	-854	1152	7572	1	1	1
9' 10"	40.32	2742	14742	-7760	16660	-774	-845	1146	7513	1	2	2
11' 6"	38.77	2636	13357	-6491	14850	-774	-836	1139	7457	2	2	3
13' 1"	36.9	2509	11986	-5221	13073	-774	-827	1133	7403	2	3	4
14' 9"	34.77	2364	10629	-3952	11339	-774	-819	1126	7351	2	4	5
16' 5"	32.42	2205	9285	-2683	9665	-773	-811	1120	7302	3	5	6
18' 1"	29.8	2026	7956	-1414	8081	-773	-802	1114	7254	3	6	7
19' 8"	26.93	1831	6640	-145	6641	-773	-795	1109	7214	4	7	8
21' 0"	23.86	1622	5594	1006	5683	3310	-612	3366	6792	4	8	9
21' 4"	21.32	1450	5395	-71	5395	3310	-610	3365	6784	5	8	9
21' 7"	20.59	1400	5237	-932	5319	-81	-546	551	876	5	8	10
23' 0"	19.31	1313	4484	-821	4558	-81	-539	545	839	5	10	11
24' 7"	17.72	1205	3600	-689	3666	-80	-531	537	800	6	11	12
26' 3"	15.38	1046	2729	-557	2785	-80	-524	530	762	6	12	14
27' 11"	12.68	862	1869	-425	1917	-80	-517	523	727	7	14	15
29' 6"	9.51	646	1020	-294	1062	-80	-514	520	709	7	15	17
29' 7"	5.6	381	1087	-287	1124	-40	-262	265	372	7	15	17
31' 2"	6.03	410	672	-224	708	-40	-256	260	346	8	17	18
32' 3"	4.11	279	1	0	1	0	-2	2	10	8	18	19
32' 10"	0.01	1	0	0	0	0	-1	1	2	9	18	20
33' 1"	0	0	0	0	0	0	0	0	0	9	18	20

Extreme Wind

Heights	Stress %	Stress (lb/in <sup>2</sup> )	Moment (ft-lbf)			Force (lbf)				Displacement (in)		
			X	Y	Magnitude	X	Y	Shear Magnitude	Axial	X	Y	Magnitude
0' 0"	17.48	1049	8456	-5035	9842	-285	-519	592	2490	0	0	0
0' 1"	17.55	1053	8422	-5016	9803	-284	-517	590	2488	0	0	0
0' 2"	17.53	1052	8354	-4979	9725	-284	-515	588	2485	0	0	0
0' 4"	17.46	1048	8287	-4942	9648	-283	-508	582	2476	0	0	0
1' 0"	17.57	1054	7953	-4756	9267	-282	-497	571	2461	0	0	0
1' 8"	17.27	1036	7627	-4571	8892	-279	-477	553	2435	0	0	0
3' 3"	17.22	1033	6844	-4114	7985	-275	-450	527	2398	0	0	0
4' 11"	16.4	984	6107	-3663	7121	-271	-422	502	2364	0	0	0
6' 7"	15.54	933	5414	-3218	6298	-267	-396	478	2330	0	0	0
8' 2"	14.62	877	4765	-2780	5516	-264	-370	454	2298	0	0	0
9' 10"	13.64	818	4158	-2348	4775	-260	-344	431	2267	0	1	1
11' 6"	12.62	757	3594	-1921	4075	-256	-319	409	2238	0	1	1
13' 1"	11.53	692	3071	-1500	3418	-253	-294	388	2209	1	1	1
14' 9"	10.38	623	2588	-1085	2806	-250	-270	368	2182	1	1	2
16' 5"	9.19	552	2144	-676	2248	-246	-247	349	2156	1	2	2
18' 1"	7.99	479	1740	-272	1761	-243	-224	330	2131	1	2	2
19' 8"	6.82	409	1372	127	1378	-240	-204	315	2110	1	2	3
21' 0"	5.81	348	1105	466	1199	1031	-191	1048	2032	1	2	3
21' 4"	5.29	318	1043	130	1051	1031	-187	1048	2028	1	3	3
21' 7"	4.78	287	997	-139	1007	-20	-152	154	187	1	3	3
23' 0"	4.15	249	787	-111	794	-17	-133	134	167	2	3	3
24' 7"	3.51	210	569	-83	575	-14	-112	113	147	2	3	4
26' 3"	2.74	164	385	-59	390	-11	-92	92	127	2	4	4
27' 11"	2.02	121	235	-41	239	-9	-72	72	109	2	4	5
29' 6"	1.35	81	118	-26	120	-7	-62	62	99	2	4	5
29' 7"	0.73	44	124	-26	126	-6	-45	46	59	2	4	5
31' 2"	0.77	46	52	-17	54	-3	-30	30	45	2	5	5
32' 3"	0.37	22	4	-1	4	-1	-6	6	5	3	5	6
32' 10"	0.03	2	0	0	0	0	-2	2	1	3	5	6
33' 1"	0	0	0	0	0	0	0	0	0	3	5	6

Measured: Existing

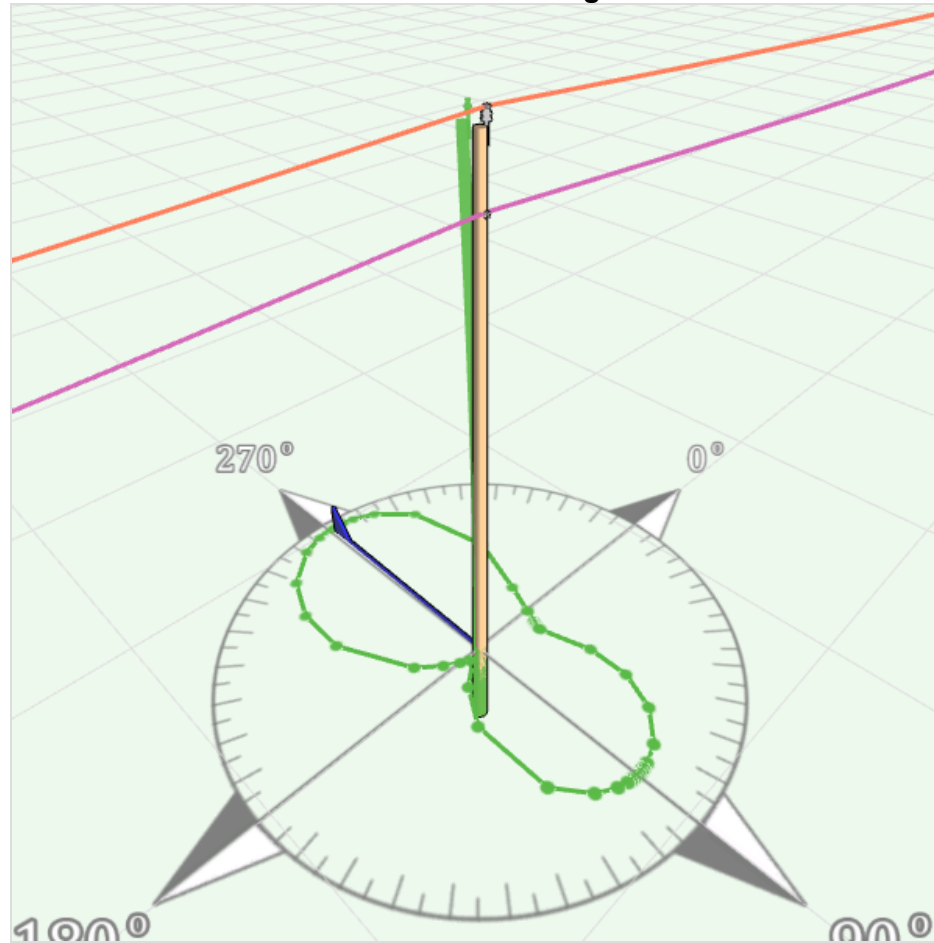

Design Properties

Owner:	Unset Com Owner
Species:	Southern Pine
Length:	40'
Class:	4
AGL:	33' 1"
GLC:	33' 1/4"
Foundation:	None
Ground Water Level:	None
Lean Angle:	0°
Lean Direction:	0°
Capacity Adjustment:	100%
Effective Allowable Stress:	8000 lb/in <sup>2</sup>
GPS Location:	Undefined.
Map Location:	38.94577862728448 , -91.07688102775653

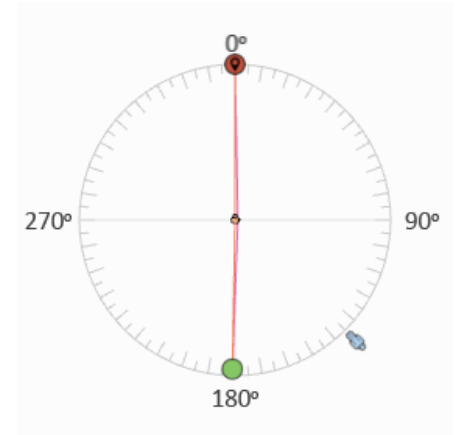
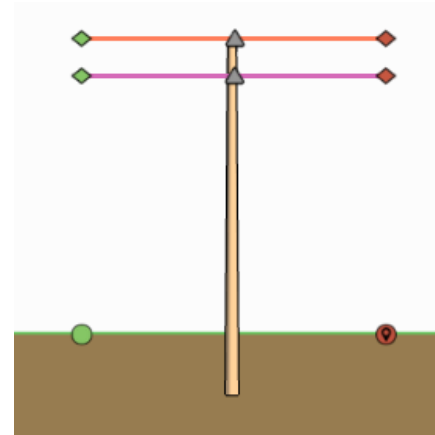

**Design Warnings**

Type	Description
Analysis Near Capacity	6 Copperweld Type A, Full loading for Heavy Grade C - 56.40 %

**Load Case Properties**

	Heavy Grade C (Governing Case)	Extreme Wind
LoadCase Type	NESC 2012 Heavy	NESC Extreme Wind 2012
Construction Grade	C	B
Construction Type	New	New
Temperature	0 °F	60 °F
Wind Pressure	4 lb/ft²	90 mph
Ice Thickness	0.5"	0"
Wind	Sweep	Sweep
Wind Direction	0 °	0 °
Wind Increment	1 °	1 °
Analysis Method	Basic (Direct Stiffness)	Basic (Direct Stiffness)
Load Percentage Allowed	100%	100%
Average Length on Main Span	No	No
Displacement Based Load Changes	None	None
Analyze Ground Line Only	No	No
Analyze with Buckling Case	No	No
Analyze with Deflection Case	No	No
Analyze with Strength Results	No	No
Custom	No	No

**Analysis Results**

**Loading**

Component	Heavy Grade C (Governing Case)			Extreme Wind			Client File Maximum Rating
	Max %	Load (Applied / Allowable)	Wind Direction	Max %	Load (Applied / Allowable)	Wind Direction	
Pole - Stress	29.15 from stress	1982 lb/in² / 6800 lb/in²	271 °	13.98 from stress	839 lb/in² / 6000 lb/in²	273 °	8000 lb/in²
3" Spool Bolt [29' 7"] (Insulator#1) - Force	13.6	408 lbf / 3000 lbf	270 °	1.09	33 lbf / 3000 lbf	270 °	3000 lbf
24.9 kV Pin Type Insulator (Pole Top) [32' 3"] (Insulator#2) - Force	8.15	408 lbf / 5000 lbf	270 °	0.65	33 lbf / 5000 lbf	270 °	5000 lbf
6 Copperweld Type A, Full (Wire#4) - Tension	56.4	1458 lbf / 1551 lbf	N/A	N/A	N/A	N/A	2585 lbf

**Pole Analysis Charts for Governing Load Case: Heavy Grade C**

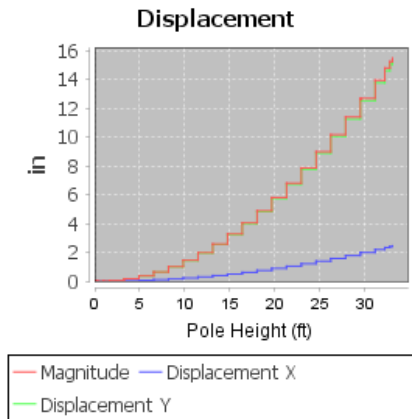
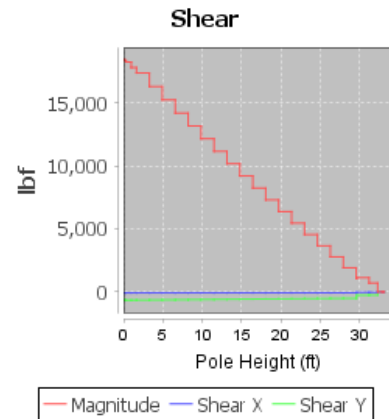
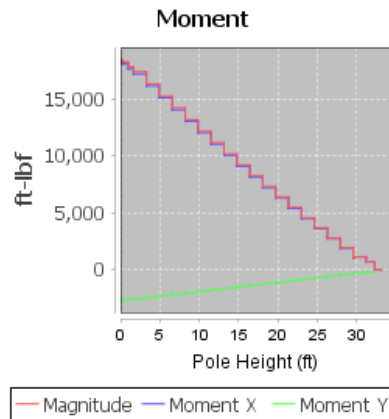
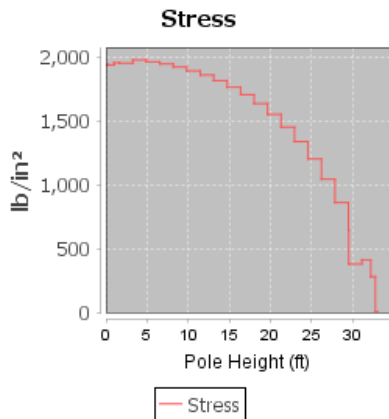

**Pole Static Analysis**

Heavy Grade C

Heights	Stress %	Stress (lb/in <sup>2</sup> )	Moment (ft-lbf)			Force (lbf)				Displacement (in)		
			X	Y	Magnitude	X	Y	Shear Magnitude	Axial	X	Y	Magnitude
0' 0"	28.49	1938	18285	-2696	18483	-83	-666	671	1651	0	0	0
0' 1"	28.56	1942	18242	-2691	18439	-83	-665	670	1646	0	0	0
0' 2"	28.57	1943	18155	-2680	18351	-83	-664	669	1640	0	0	0
0' 4"	28.55	1942	18067	-2669	18263	-83	-662	667	1623	0	0	0
1' 0"	28.81	1959	17633	-2615	17826	-83	-658	663	1594	0	0	0
1' 8"	28.76	1956	17201	-2560	17391	-83	-651	656	1545	0	0	0
3' 3"	29.15	1982	16134	-2425	16315	-82	-641	646	1476	0	0	0
4' 11"	28.92	1967	15082	-2290	15255	-82	-632	637	1410	0	0	0
6' 7"	28.67	1950	14046	-2155	14210	-82	-622	628	1346	0	1	1
8' 2"	28.32	1925	13025	-2020	13181	-82	-613	618	1285	0	1	1
9' 10"	27.88	1896	12020	-1886	12167	-82	-604	610	1227	0	1	1
11' 6"	27.38	1862	11029	-1752	11167	-82	-595	601	1170	0	2	2
13' 1"	26.75	1819	10052	-1618	10182	-81	-587	592	1116	0	3	3
14' 9"	25.98	1767	9090	-1485	9210	-81	-578	584	1065	0	3	3
16' 5"	25.12	1708	8142	-1351	8253	-81	-570	576	1015	1	4	4
18' 1"	24.1	1639	7207	-1218	7309	-81	-562	568	968	1	5	5
19' 8"	22.85	1554	6285	-1086	6378	-81	-554	560	923	1	6	6
21' 4"	21.38	1454	5376	-953	5460	-81	-546	552	880	1	7	7
23' 0"	19.7	1340	4480	-820	4555	-81	-539	545	839	1	8	8
24' 7"	17.7	1204	3597	-688	3662	-80	-531	537	800	1	9	9
26' 3"	15.36	1045	2725	-556	2781	-80	-524	530	763	2	10	10
27' 11"	12.67	861	1865	-425	1913	-80	-517	523	727	2	11	11
29' 6"	9.49	645	1017	-293	1058	-80	-514	520	710	2	12	13
29' 7"	5.58	379	1090	-288	1128	-40	-262	265	372	2	13	13
31' 2"	6.05	411	672	-224	708	-40	-256	260	346	2	14	14
32' 3"	4.11	279	1	0	1	0	-2	2	10	2	15	15
32' 10"	0.01	1	0	0	0	0	-1	1	3	2	15	15
33' 1"	0	0	0	0	0	0	0	0	0	2	15	15

Extreme Wind

Heights	Stress %	Stress (lb/in <sup>2</sup> )	Moment (ft-lbf)			Force (lbf)				Displacement (in)		
			X	Y	Magnitude	X	Y	Shear Magnitude	Axial	X	Y	Magnitude
0' 0"	13.92	835	7984	-416	7994	-26	-498	499	595	0	0	0
0' 1"	13.98	839	7951	-414	7962	-26	-496	497	592	0	0	0
0' 2"	13.96	838	7886	-411	7896	-25	-494	495	589	0	0	0
0' 4"	13.9	834	7821	-407	7832	-25	-487	488	580	0	0	0
1' 0"	13.98	839	7501	-391	7511	-24	-476	476	565	0	0	0
1' 8"	13.71	823	7189	-375	7199	-23	-456	457	539	0	0	0
3' 3"	13.65	819	6441	-336	6450	-22	-428	429	503	0	0	0
4' 11"	12.94	776	5739	-300	5747	-21	-401	401	468	0	0	0
6' 7"	12.23	734	5082	-267	5089	-19	-374	374	434	0	0	0
8' 2"	11.48	689	4469	-235	4475	-18	-347	348	402	0	0	0
9' 10"	10.72	643	3899	-206	3905	-16	-322	322	371	0	1	1
11' 6"	9.96	597	3372	-179	3377	-15	-296	297	342	0	1	1
13' 1"	9.16	550	2886	-155	2890	-14	-271	272	313	0	1	1
14' 9"	8.36	501	2441	-132	2444	-12	-247	248	286	0	1	1
16' 5"	7.56	453	2035	-112	2038	-11	-223	224	260	0	1	1
18' 1"	6.75	405	1668	-93	1671	-10	-200	201	235	0	2	2
19' 8"	5.92	355	1340	-77	1342	-9	-178	178	212	0	2	2
21' 4"	5.1	306	1048	-62	1050	-8	-156	156	189	0	2	2
23' 0"	4.3	258	793	-50	795	-7	-134	134	167	0	3	3
24' 7"	3.51	210	574	-39	575	-5	-113	113	147	0	3	3
26' 3"	2.74	165	389	-30	390	-4	-92	92	127	0	3	3
27' 11"	2.02	121	237	-23	238	-3	-72	72	109	0	4	4
29' 6"	1.35	81	119	-17	120	-3	-62	62	99	0	4	4
29' 7"	0.72	43	125	-17	127	-2	-46	46	59	0	4	4
31' 2"	0.78	47	52	-14	54	-1	-30	30	45	0	4	4
32' 3"	0.36	22	4	0	4	0	-6	6	5	0	5	5
32' 10"	0.03	2	0	0	0	0	-2	2	1	0	5	5
33' 1"	0	0	0	0	0	0	0	0	0	0	5	5



Measured: Proposed

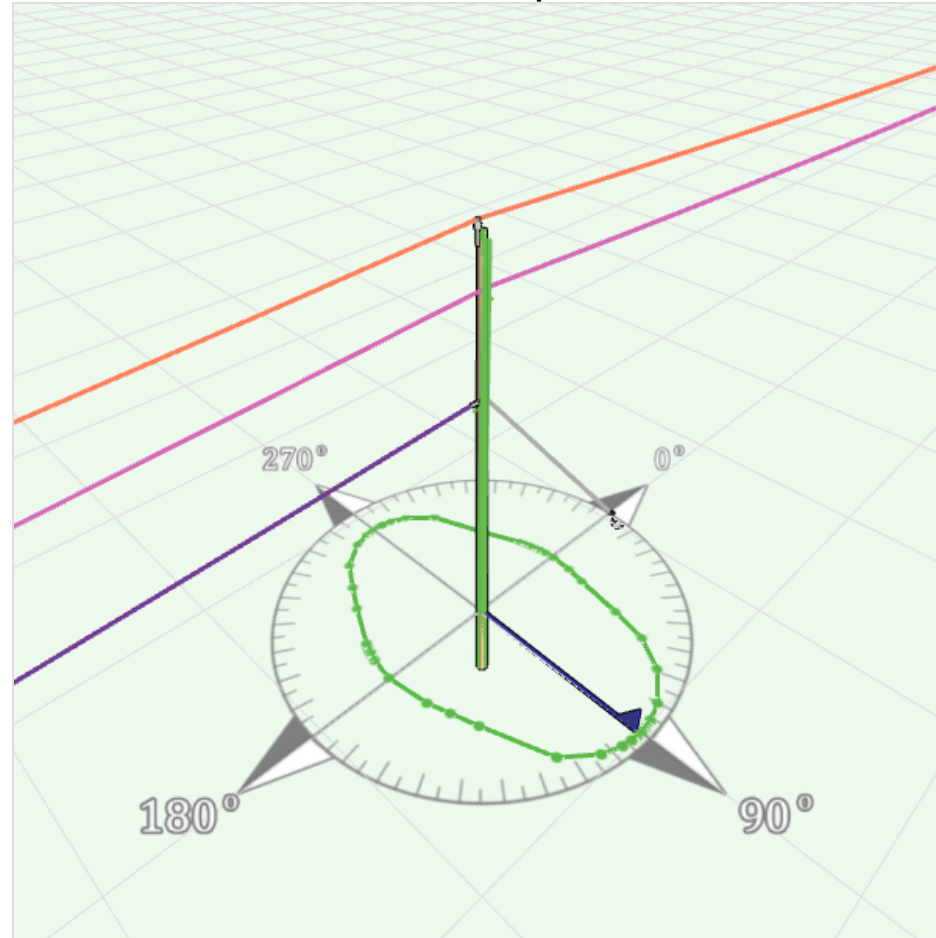

### Design Properties

**Owner:** Unset Com Owner  
**Species:** Southern Pine  
**Length:** 40'  
**Class:** 4  
**AGL:** 32' 10"  
**GLC:** 33"  
**Foundation:** None  
**Ground Water Level:** None  
**Lean Angle:** 0 °  
**Lean Direction:** 0 °  
**Capacity Adjustment:** 100%  
**Effective Allowable Stress:** 8000 lb/in²  
**GPS Location:** Undefined.  
**Map Location:** 38.9466199175189 , -91.07688102775653

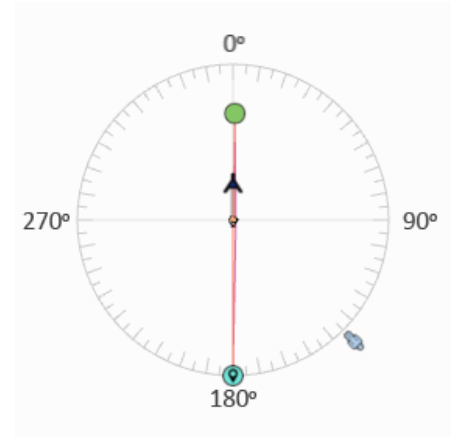
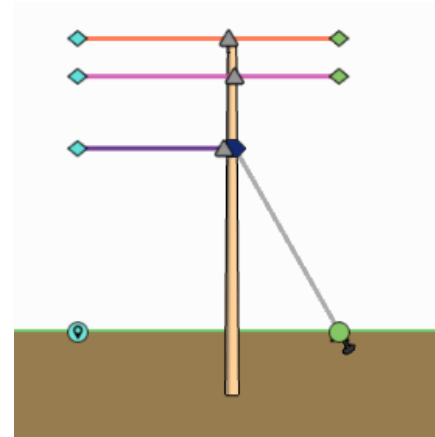

### Design Warnings

Type	Description
Analysis Near Capacity	1/4" EHS [21' 0"] loading for Heavy Grade C - 99.98 %

### Load Case Properties

	Heavy Grade C (Governing Case)	Extreme Wind
LoadCase Type	NESC 2012 Heavy	NESC Extreme Wind 2012
Construction Grade	C	B
Construction Type	New	New
Temperature	0 °F	60 °F
Wind Pressure	4 lb/ft²	90 mph
Ice Thickness	0.5"	0"
Wind	Sweep	Sweep
Wind Direction	0 °	0 °
Wind Increment	1 °	1 °
Analysis Method	Basic (Direct Stiffness)	Basic (Direct Stiffness)
Load Percentage Allowed	100%	100%
Average Length on Main Span	No	No
Displacement Based Load Changes	None	None
Analyze Ground Line Only	No	No
Analyze with Buckling Case	No	No
Analyze with Deflection Case	No	No
Analyze with Strength Results	No	No
Custom	No	No

### Analysis Results

#### Loading

Component	Heavy Grade C (Governing Case)			Extreme Wind			Client File Maximum Rating
	Max %	Load (Applied / Allowable)	Wind Direction	Max %	Load (Applied / Allowable)	Wind Direction	
Pole - Stress	36.33 from stress	2471 lb/in² / 6800 lb/in²	91 °	15.14 from stress	908 lb/in² / 6000 lb/in²	95 °	8000 lb/in²
3" Spool Bolt [29' 3"] (Insulator#1) - Force	15.55	467 lbf / 3000 lbf	89 °	0.95	28 lbf / 3000 lbf	91 °	3000 lbf
24.9 kV Pin Type Insulator (Pole Top) [32' 0"] (Insulator#2) - Force	9.32	466 lbf / 5000 lbf	89 °	0.57	29 lbf / 5000 lbf	90 °	5000 lbf
Comm D/E Bolt [21' 0"] (Insulator#3) - Force	58.66	4106 lbf / 7000 lbf	270 °	18.16	1272 lbf / 7000 lbf	135 °	7000 lbf
Proposed Fiber 1", Full (ProposedWire#1) - Tension	28.15	3153 lbf / 6720 lbf	N/A	N/A	N/A	N/A	11200 lbf
6 Copperweld Type A, Full (Wire#3) - Tension	56.4	1458 lbf / 1551 lbf	N/A	N/A	N/A	N/A	2585 lbf
1/4" EHS [21' 0"] (DownGuy#1) - Force	99.98	5984 lbf / 5985 lbf	95 °	36.1	2161 lbf / 5985 lbf	180 °	6650 lbf
Proposed Anchor [17' 0", 0 °] (Anchor#1) - Force	85.48	5984 lbf / 7000 lbf	95 °	30.87	2161 lbf / 7000 lbf	180 °	7000 lbf

Pole Analysis Charts for Governing Load Case: Heavy Grade C

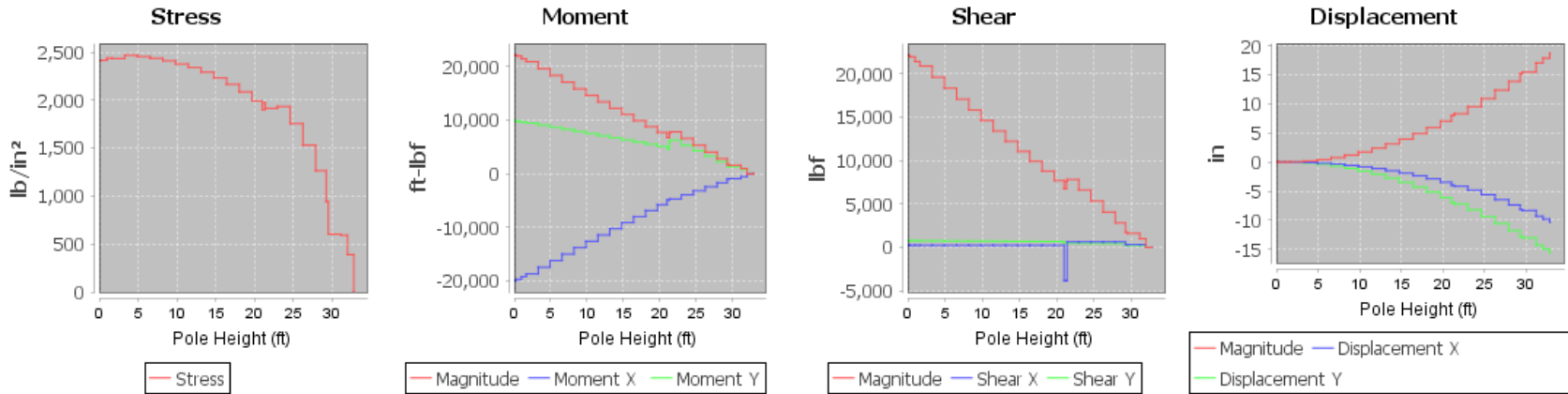

Pole Static Analysis

Heavy Grade C

Heights	Stress %	Stress (lb/in <sup>2</sup> )	Moment (ft-lbf)			Force (lbf)					Displacement (in)		
			X	Y	Magnitude	X	Y	Shear Magnitude	Axial	X	Y	Magnitude	
0' 0"	35.47	2412	-19903	9880	22220	241	776	813	7433	0	0	0	
0' 1"	35.55	2418	-19852	9864	22168	241	775	812	7428	0	0	0	
0' 2"	35.57	2419	-19751	9832	22063	241	775	811	7422	0	0	0	
0' 4"	35.55	2417	-19649	9800	21958	241	772	809	7405	0	0	0	
1' 0"	35.88	2440	-19142	9642	21434	241	768	805	7376	0	0	0	
1' 8"	35.83	2437	-18638	9484	20913	241	761	798	7327	0	0	0	
3' 3"	36.33	2471	-17390	9089	19621	241	752	789	7259	0	0	0	
4' 11"	36.11	2455	-16157	8694	18347	241	742	780	7193	0	0	0	
6' 7"	35.86	2439	-14939	8299	17090	240	733	771	7130	0	-1	1	
8' 2"	35.47	2412	-13738	7904	15849	240	724	762	7069	-1	-1	1	
9' 10"	34.99	2379	-12551	7510	14626	240	715	754	7011	-1	-2	2	
11' 6"	34.44	2342	-11378	7116	13420	240	706	745	6955	-1	-2	2	
13' 1"	33.72	2293	-10221	6722	12233	240	697	737	6902	-1	-3	3	
14' 9"	32.85	2234	-9077	6329	11066	240	689	729	6850	-2	-3	4	
16' 5"	31.87	2167	-7947	5936	9919	240	681	721	6801	-2	-4	5	
18' 1"	30.71	2088	-6831	5543	8797	239	672	714	6754	-3	-5	6	
19' 8"	29.31	1993	-5728	5150	7702	239	665	707	6714	-3	-6	7	
21' 0"	27.95	1900	-4853	4701	6756	-3843	482	3874	6292	-4	-7	8	
21' 4"	29.03	1974	-4696	5952	7581	-3843	481	3873	6287	-4	-7	8	
21' 5"	28.19	1917	-4655	6288	7824	619	475	780	783	-4	-7	8	
23' 0"	28.46	1935	-3917	5327	6612	619	468	776	743	-5	-8	10	
24' 7"	25.84	1757	-3150	4312	5340	619	460	771	705	-6	-9	11	
26' 3"	22.51	1531	-2394	3297	4075	619	453	767	668	-6	-11	12	
27' 11"	18.62	1266	-1651	2282	2817	618	447	763	636	-7	-12	14	
29' 3"	13.9	945	-960	1441	1731	309	230	385	342	-8	-13	15	
29' 6"	8.86	603	-896	1355	1624	309	226	383	323	-8	-13	15	
31' 2"	8.72	593	-525	848	997	309	221	380	299	-9	-14	17	
32' 0"	5.74	391	-1	0	1	0	2	2	8	-10	-15	18	
32' 10"	0.01	1	0	0	0	0	0	0	0	-10	-16	19	
32' 10"	0	0	0	0	0	0	0	0	0	-10	-16	19	

**Extreme Wind**

Heights	Stress %	Stress (lb/in <sup>2</sup> )	Moment (ft-lbf)			Force (lbf)				Displacement (in)		
			X	Y	Magnitude	X	Y	Shear Magnitude	Axial	X	Y	Magnitude
0' 0"	15.07	904	-7628	3584	8428	201	475	516	2009	0	0	0
0' 1"	15.13	908	-7597	3570	8394	201	473	514	2007	0	0	0
0' 2"	15.11	907	-7535	3544	8327	201	471	512	2004	0	0	0
0' 4"	15.05	903	-7473	3518	8260	200	464	506	1995	0	0	0
1' 0"	15.14	908	-7168	3386	7928	199	454	495	1980	0	0	0
1' 8"	14.87	892	-6871	3255	7603	198	435	478	1954	0	0	0
3' 3"	14.83	890	-6157	2931	6819	195	409	453	1918	0	0	0
4' 11"	14.1	846	-5487	2611	6076	193	383	429	1883	0	0	0
6' 7"	13.35	801	-4859	2294	5373	191	358	405	1850	0	0	0
8' 2"	12.55	753	-4272	1981	4709	189	333	383	1818	0	0	0
9' 10"	11.72	703	-3727	1671	4084	187	308	360	1787	0	-1	1
11' 6"	10.86	652	-3221	1365	3498	185	285	339	1758	0	-1	1
13' 1"	9.95	597	-2754	1063	2952	182	261	319	1730	0	-1	1
14' 9"	9	540	-2325	763	2447	180	238	299	1703	-1	-1	1
16' 5"	8.04	482	-1934	467	1990	179	216	280	1677	-1	-1	2
18' 1"	7.07	424	-1579	174	1589	177	194	263	1652	-1	-2	2
19' 8"	6.13	368	-1260	-115	1266	175	175	248	1631	-1	-2	2
21' 0"	5.29	317	-1030	-368	1094	-1095	163	1107	1553	-1	-2	2
21' 4"	4.78	287	-977	-11	977	-1095	160	1107	1550	-1	-2	3
21' 5"	4.36	262	-965	85	969	12	144	145	176	-1	-2	3
23' 0"	4.02	241	-742	67	745	10	124	125	155	-1	-3	3
24' 7"	3.32	199	-537	50	540	8	105	105	135	-1	-3	3
26' 3"	2.6	156	-366	37	368	7	85	86	116	-1	-3	4
27' 11"	1.93	116	-226	26	227	5	68	68	99	-2	-4	4
29' 3"	1.29	77	-125	19	126	4	52	52	62	-2	-4	4
29' 6"	0.75	45	-111	18	112	3	41	42	52	-2	-4	4
31' 2"	0.69	42	-43	13	45	2	28	28	40	-2	-4	5
32' 0"	0.3	18	-4	0	4	0	5	5	4	-2	-5	5
32' 10"	0.03	2	0	0	0	0	0	0	0	-2	-5	5
32' 10"	0	0	0	0	0	0	0	0	0	-2	-5	5

Measured: Existing

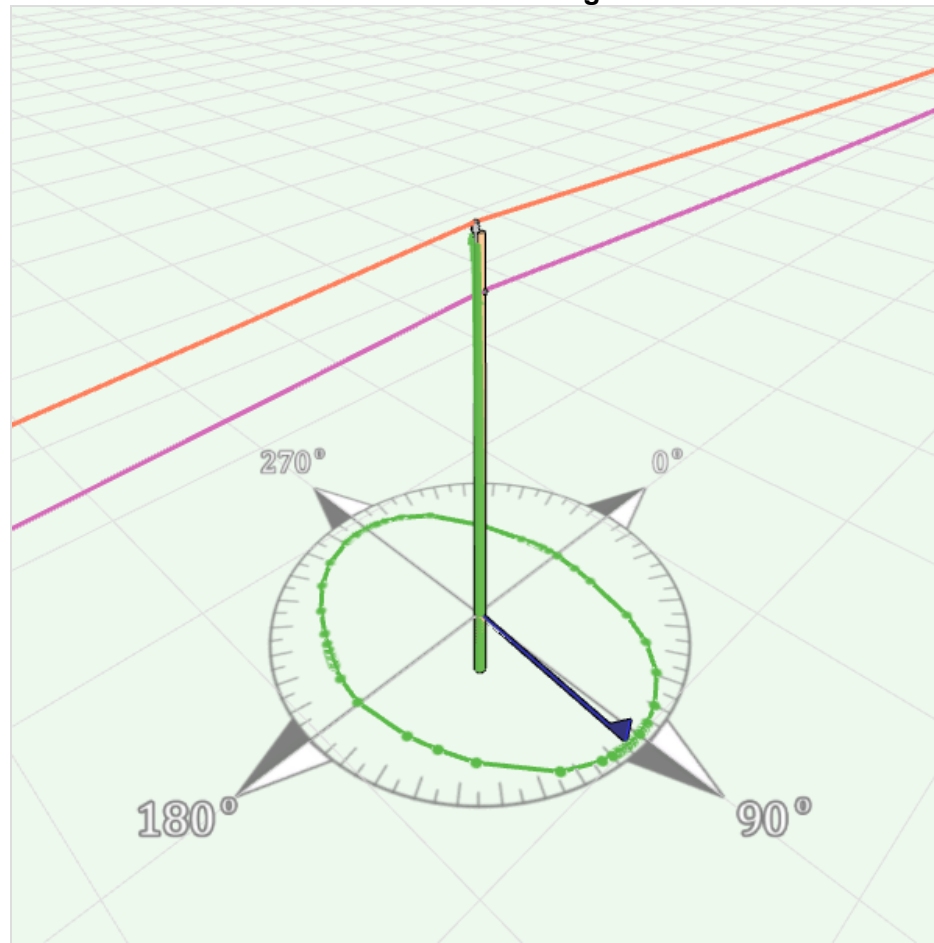

Design Properties

<b>Owner:</b>	Unset Com Owner
<b>Species:</b>	Southern Pine
<b>Length:</b>	40'
<b>Class:</b>	4
<b>AGL:</b>	32' 10"
<b>GLC:</b>	33"
<b>Foundation:</b>	None
<b>Ground Water Level:</b>	None
<b>Lean Angle:</b>	0°
<b>Lean Direction:</b>	0°
<b>Capacity Adjustment:</b>	100%
<b>Effective Allowable Stress:</b>	8000 lb/in <sup>2</sup>
<b>GPS Location:</b>	Undefined.
<b>Map Location:</b>	38.9466199175189, -91.07688102775653

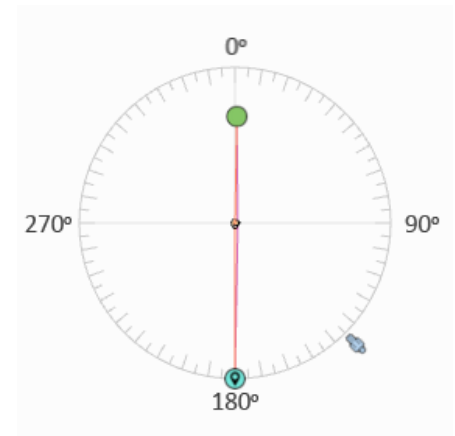
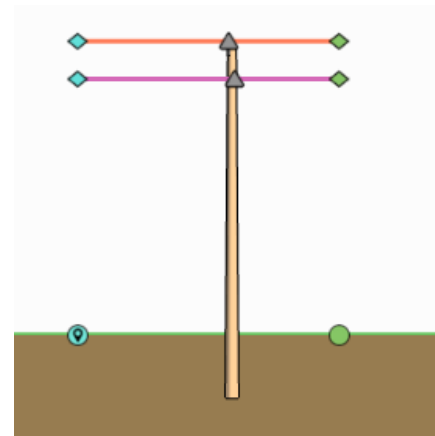

**Design Warnings**

Type	Description
Analysis Near Capacity	6 Copperweld Type A, Full loading for Heavy Grade C - 56.40 %

**Load Case Properties**

	Heavy Grade C (Governing Case)	Extreme Wind
LoadCase Type	NESC 2012 Heavy	NESC Extreme Wind 2012
Construction Grade	C	B
Construction Type	New	New
Temperature	0 °F	60 °F
Wind Pressure	4 lb/ft²	90 mph
Ice Thickness	0.5"	0"
Wind	Sweep	Sweep
Wind Direction	0 °	0 °
Wind Increment	1 °	1 °
Analysis Method	Basic (Direct Stiffness)	Basic (Direct Stiffness)
Load Percentage Allowed	100%	100%
Average Length on Main Span	No	No
Displacement Based Load Changes	None	None
Analyze Ground Line Only	No	No
Analyze with Buckling Case	No	No
Analyze with Deflection Case	No	No
Analyze with Strength Results	No	No
Custom	No	No

**Analysis Results**

**Loading**

Component	Heavy Grade C (Governing Case)			Extreme Wind			Client File Maximum Rating
	Max %	Load (Applied / Allowable)	Wind Direction	Max %	Load (Applied / Allowable)	Wind Direction	
Pole - Stress	40.42 from stress	2749 lb/in² / 6800 lb/in²	94 °	13.23 from stress	794 lb/in² / 6000 lb/in²	92 °	8000 lb/in²
3" Spool Bolt [29' 3"] (Insulator#1) - Force	15.55	467 lbf / 3000 lbf	89 °	0.95	28 lbf / 3000 lbf	91 °	3000 lbf
24.9 kV Pin Type Insulator (Pole Top) [32' 0"] (Insulator#2) - Force	9.32	466 lbf / 5000 lbf	89 °	0.57	29 lbf / 5000 lbf	91 °	5000 lbf
6 Copperweld Type A, Full (Wire#3) - Tension	56.4	1458 lbf / 1551 lbf	N/A	N/A	N/A	N/A	2585 lbf

**Pole Analysis Charts for Governing Load Case: Heavy Grade C**

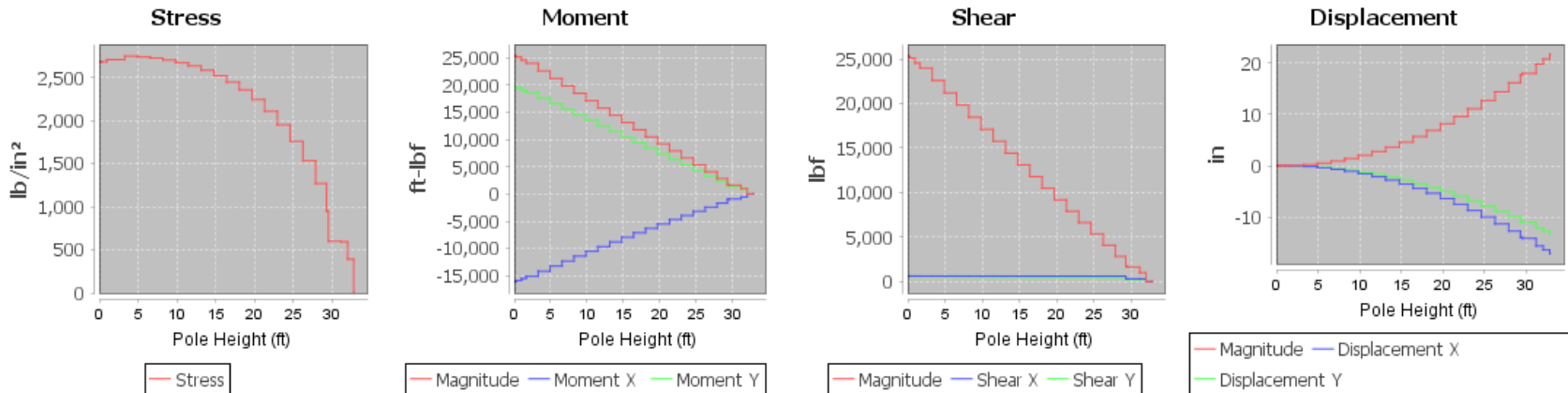

**Pole Static Analysis**

Heavy Grade C

Heights	Stress %	Stress (lb/in <sup>2</sup> )	Moment (ft-lbf)			Force (lbf)				Displacement (in)		
			X	Y	Magnitude	X	Y	Shear Magnitude	Axial	X	Y	Magnitude
0' 0"	39.36	2676	-16047	19673	25388	628	592	864	1550	0	0	0
0' 1"	39.45	2682	-16009	19632	25331	628	592	863	1546	0	0	0
0' 2"	39.47	2684	-15931	19549	25218	628	591	863	1540	0	0	0
0' 4"	39.46	2683	-15853	19467	25105	628	589	861	1522	0	0	0
1' 0"	39.83	2708	-15467	19054	24542	628	585	858	1494	0	0	0
1' 8"	39.82	2708	-15084	18642	23980	627	578	853	1445	0	0	0
3' 3"	40.42	2749	-14136	17613	22584	627	568	846	1376	0	0	0
4' 11"	40.27	2738	-13204	16585	21199	626	559	839	1311	0	0	0
6' 7"	40.09	2726	-12287	15558	19825	625	549	832	1248	-1	-1	1
8' 2"	39.75	2703	-11386	14532	18462	625	540	826	1187	-1	-1	1
9' 10"	39.29	2671	-10500	13507	17108	624	531	820	1129	-2	-1	2
11' 6"	38.75	2635	-9629	12483	15765	624	522	813	1073	-2	-2	3
13' 1"	38	2584	-8772	11460	14432	623	514	808	1019	-3	-2	4
14' 9"	37.07	2521	-7929	10439	13108	622	505	802	968	-4	-3	5
16' 5"	35.99	2447	-7100	9418	11794	622	497	796	919	-4	-4	6
18' 1"	34.66	2357	-6284	8398	10488	621	489	791	872	-5	-4	7
19' 8"	33	2244	-5482	7378	9192	621	481	785	827	-6	-5	8
21' 4"	31.01	2109	-4692	6360	7904	620	474	780	784	-8	-6	10
23' 0"	28.7	1951	-3915	5343	6624	620	466	775	743	-9	-7	11
24' 7"	25.89	1760	-3150	4327	5352	619	459	771	705	-10	-8	13
26' 3"	22.56	1534	-2397	3311	4088	619	452	766	668	-11	-9	14
27' 11"	18.68	1270	-1656	2296	2831	618	445	762	635	-13	-10	16
29' 3"	13.97	950	-952	1434	1721	310	229	385	342	-14	-11	18
29' 6"	8.81	599	-896	1359	1628	309	225	383	323	-14	-11	18
31' 2"	8.74	594	-527	851	1001	309	220	379	299	-16	-12	20
32' 0"	5.77	392	-1	0	1	0	2	2	8	-16	-13	21
32' 10"	0.01	1	0	0	0	0	0	0	0	-17	-13	22
32' 10"	0	0	0	0	0	0	0	0	0	-17	-13	22

**Extreme Wind**

Heights	Stress %	Stress (lb/in <sup>2</sup> )	Moment (ft-lbf)			Force (lbf)				Displacement (in)		
			X	Y	Magnitude	X	Y	Shear Magnitude	Axial	X	Y	Magnitude
0' 0"	13.17	790	-7494	262	7499	16	469	469	580	0	0	0
0' 1"	13.23	794	-7463	261	7468	16	467	467	578	0	0	0
0' 2"	13.21	793	-7402	259	7407	16	465	465	575	0	0	0
0' 4"	13.16	789	-7341	257	7345	16	458	459	565	0	0	0
1' 0"	13.23	794	-7040	247	7045	15	447	448	550	0	0	0
1' 8"	12.98	779	-6747	237	6751	15	429	429	524	0	0	0
3' 3"	12.92	775	-6043	213	6047	14	402	403	489	0	0	0
4' 11"	12.25	735	-5383	190	5387	13	377	377	454	0	0	0
6' 7"	11.57	694	-4766	169	4769	12	351	351	421	0	0	0
8' 2"	10.86	652	-4190	149	4192	11	326	326	389	0	0	0
9' 10"	10.14	608	-3654	131	3657	10	302	302	358	0	-1	1
11' 6"	9.42	565	-3159	114	3161	9	278	278	329	0	-1	1
13' 1"	8.67	520	-2703	99	2705	9	255	255	301	0	-1	1
14' 9"	7.9	474	-2286	85	2287	8	232	232	273	0	-1	1
16' 5"	7.15	429	-1905	72	1907	7	209	209	248	0	-1	1
18' 1"	6.38	383	-1562	60	1563	6	187	188	223	0	-2	2
19' 8"	5.6	336	-1255	50	1256	6	166	166	199	0	-2	2
21' 4"	4.83	290	-982	41	983	5	145	145	177	0	-2	2
23' 0"	4.07	244	-744	33	745	4	125	125	155	0	-3	3
24' 7"	3.32	199	-539	26	540	3	105	105	135	0	-3	3
26' 3"	2.6	156	-367	21	368	3	86	86	116	0	-3	3
27' 11"	1.93	116	-227	16	227	2	68	68	98	0	-4	4
29' 3"	1.29	77	-124	14	124	2	52	52	62	0	-4	4
29' 6"	0.74	44	-111	13	112	1	42	42	52	0	-4	4
31' 2"	0.69	42	-43	11	44	1	28	28	39	0	-4	4
32' 0"	0.3	18	-4	0	4	0	4	4	4	0	-4	4
32' 10"	0.03	2	0	0	0	0	0	0	0	0	-5	5
32' 10"	0	0	0	0	0	0	0	0	0	0	-5	5



Measured: Proposed

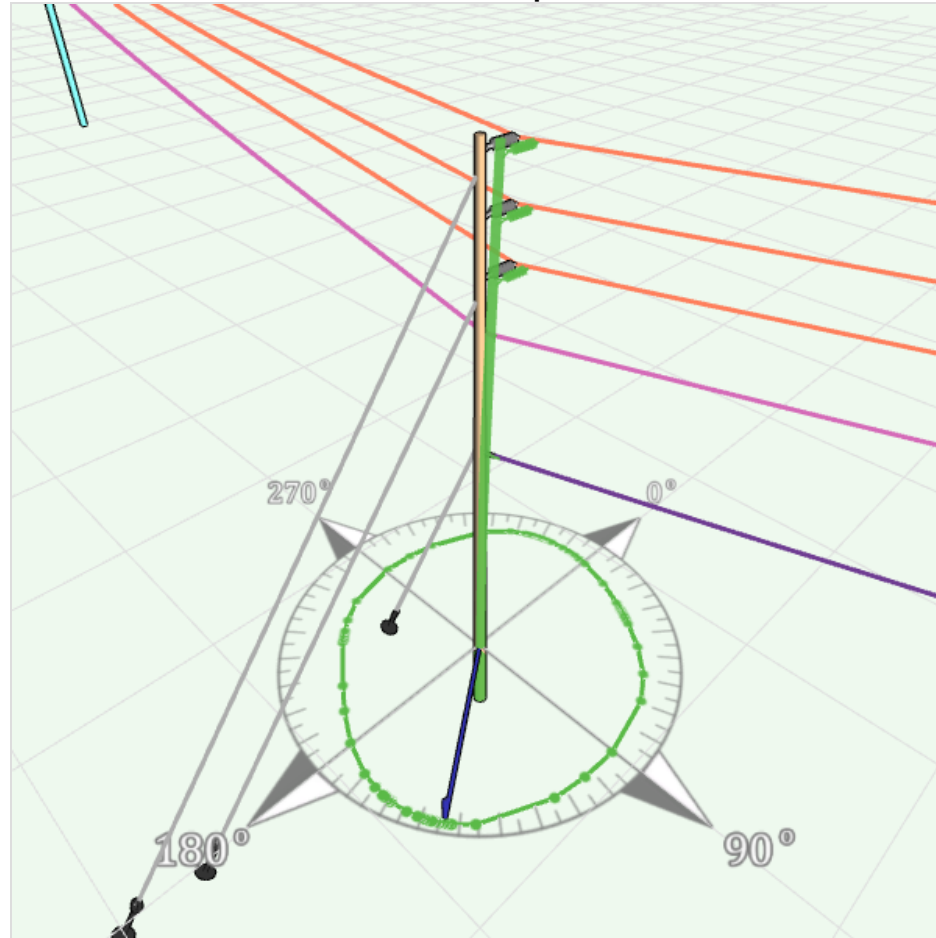

**Design Properties**

**Owner:** Unset Com Owner  
**Species:** Southern Pine  
**Length:** 50'  
**Class:** 4  
**AGL:** 42' 7"  
**GLC:** 36"  
**Foundation:** None  
**Ground Water Level:** None  
**Lean Angle:** 0 °  
**Lean Direction:** 0 °  
**Capacity Adjustment:** 100%  
**Effective Allowable Stress:** 8000 lb/in<sup>2</sup>  
**GPS Location:** Undefined.  
**Map Location:** 38.942258205843 , -91.21548927137125

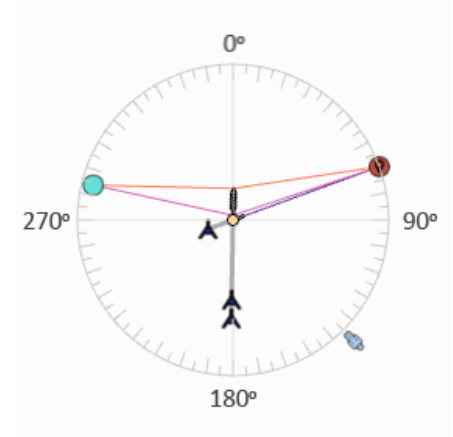
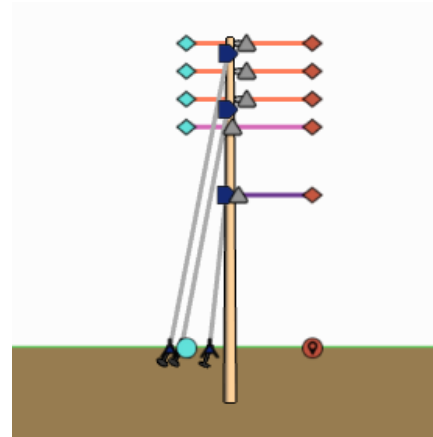

**Design Warnings**

Type	Description
Analysis Near Capacity	1/4" EHS [21' 0"] loading for Heavy Grade C - 94.04 %

**Load Case Properties**

	Heavy Grade C (Governing Case)	Extreme Wind
LoadCase Type	NESC 2012 Heavy	NESC Extreme Wind 2012
Construction Grade	C	B
Construction Type	New	New
Temperature	0 °F	60 °F
Wind Pressure	4 lb/ft <sup>2</sup>	90 mph
Ice Thickness	0.5"	0"
Wind	Sweep	Sweep
Wind Direction	0 °	0 °
Wind Increment	1 °	1 °
Analysis Method	Basic (Direct Stiffness)	Basic (Direct Stiffness)
Load Percentage Allowed	100%	100%
Average Length on Main Span	No	No
Displacement Based Load Changes	None	None
Analyze Ground Line Only	No	No
Analyze with Buckling Case	No	No
Analyze with Deflection Case	No	No
Analyze with Strength Results	No	No
Custom	No	No

### Analysis Results

#### Loading

Component	Heavy Grade C (Governing Case)			Extreme Wind			Client File Maximum Rating
	Max %	Load (Applied / Allowable)	Wind Direction	Max %	Load (Applied / Allowable)	Wind Direction	
Pole - Stress	31.26 from stress	2126 lb/in <sup>2</sup> / 6800 lb/in <sup>2</sup>	144 °	16.03 from stress	962 lb/in <sup>2</sup> / 6000 lb/in <sup>2</sup>	274 °	8000 lb/in <sup>2</sup>
3" Spool Bolt [30' 4"] (Insulator#1) - Force	42.34	1270 lbf / 3000 lbf	355 °	8.59	258 lbf / 3000 lbf	357 °	3000 lbf
24.9 kV Running Angle Insulator [34' 2"] (Insulator#2) - Force	31.97	1598 lbf / 5000 lbf	355 °	8.07	403 lbf / 5000 lbf	320 °	5000 lbf
24.9 kV Running Angle Insulator [38' 0"] (Insulator#3) - Force	31.97	1598 lbf / 5000 lbf	355 °	8.07	403 lbf / 5000 lbf	320 °	5000 lbf
24.9 kV Running Angle Insulator [41' 10"] (Insulator#4) - Force	31.97	1598 lbf / 5000 lbf	355 °	8.07	403 lbf / 5000 lbf	320 °	5000 lbf
Comm D/E Bolt [21' 0"] (Insulator#5) - Force	43.87	3071 lbf / 7000 lbf	160 °	12.7	889 lbf / 7000 lbf	115 °	7000 lbf
Proposed Fiber 1", Full (ProposedWire#1) - Tension	21.06	2359 lbf / 6720 lbf	N/A	N/A	N/A	N/A	11200 lbf
1/0 ACSR, Full (Wire#8) - Tension	44.18	1935 lbf / 2628 lbf	N/A	N/A	N/A	N/A	4380 lbf
1/4" EHS [21' 0"] (DownGuy#1) - Force	94.04	5629 lbf / 5985 lbf	143 °	42.26	2530 lbf / 5985 lbf	90 °	6650 lbf
3/8" EHS [32' 9"] (Guy#1) - Force	32.78	4544 lbf / 13860 lbf	1 °	12.32	1707 lbf / 13860 lbf	338 °	15400 lbf
3/8" EHS [40' 5"] (Guy#2) - Force	30.2	4186 lbf / 13860 lbf	353 °	9.27	1285 lbf / 13860 lbf	22 °	15400 lbf
Proposed Anchor [8' 0", 250 °] (Anchor#1) - Force	80.41	5629 lbf / 7000 lbf	143 °	36.14	2530 lbf / 7000 lbf	90 °	7000 lbf
F1-2 [25' 0", 181 °] (Anchor#2) - Force	36.35	4544 lbf / 12500 lbf	1 °	13.66	1707 lbf / 12500 lbf	338 °	12500 lbf
F1-2 [31' 0", 181 °] (Anchor#3) - Force	33.49	4186 lbf / 12500 lbf	353 °	10.28	1285 lbf / 12500 lbf	22 °	12500 lbf

#### Pole Analysis Charts for Governing Load Case: Heavy Grade C

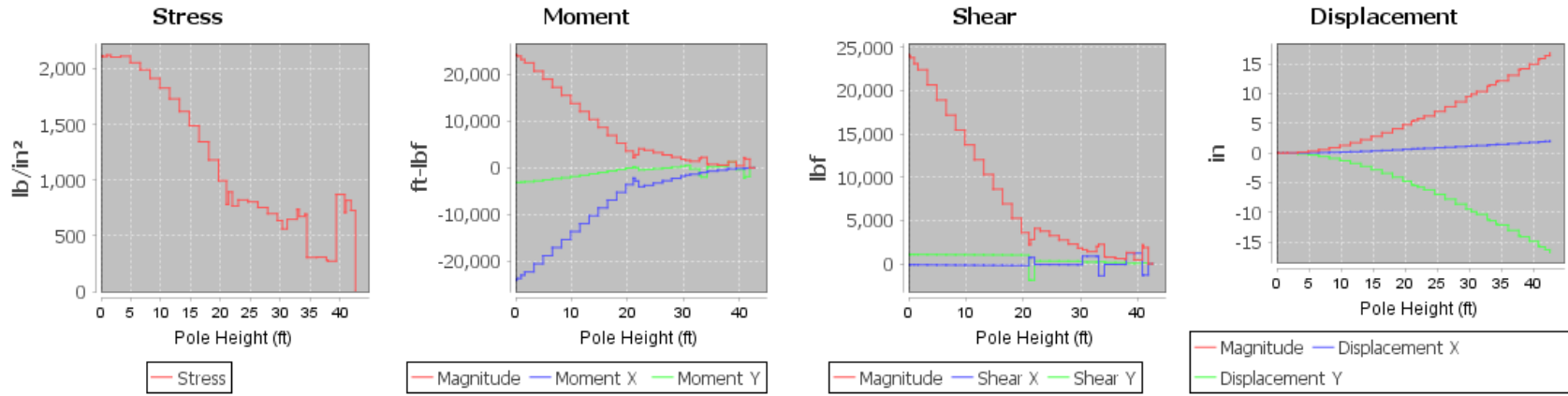

Pole Static Analysis

Heavy Grade C

Heights	Stress %	Stress (lb/in <sup>2</sup> )	Moment (ft-lbf)			Force (lbf)				Displacement (in)		
			X	Y	Magnitude	X	Y	Shear Magnitude	Axial	X	Y	Magnitude
0' 0"	31.04	2111	-23986	-3165	24194	-109	1072	1078	15068	0	0	0
0' 1"	31.13	2117	-23915	-3158	24123	-110	1072	1077	15063	0	0	0
0' 2"	31.12	2116	-23775	-3144	23982	-110	1071	1077	15056	0	0	0
0' 4"	31.06	2112	-23634	-3129	23841	-112	1070	1075	15035	0	0	0
1' 0"	31.26	2126	-22932	-3056	23135	-116	1067	1073	15001	0	0	0
1' 8"	30.98	2107	-22232	-2980	22431	-122	1063	1070	14943	0	0	0
3' 3"	31.1	2115	-20489	-2779	20677	-131	1056	1064	14861	0	0	0
4' 11"	30.25	2057	-18756	-2565	18931	-139	1050	1059	14783	0	0	0
6' 7"	29.31	1993	-17034	-2337	17193	-147	1044	1055	14706	0	-1	1
8' 2"	28.18	1916	-15321	-2095	15463	-155	1038	1050	14633	0	-1	1
9' 10"	26.9	1829	-13618	-1840	13741	-164	1032	1045	14562	0	-1	1
11' 6"	25.47	1732	-11924	-1572	12027	-171	1027	1041	14493	0	-2	2
13' 1"	23.8	1618	-10240	-1291	10321	-179	1021	1037	14427	0	-2	2
14' 9"	21.91	1490	-8565	-997	8623	-187	1016	1033	14363	0	-3	3
16' 5"	19.79	1346	-6899	-691	6933	-194	1010	1029	14302	0	-3	3
18' 1"	17.39	1183	-5242	-372	5255	-201	1005	1025	14243	1	-4	4
19' 8"	14.65	996	-3593	-42	3594	-208	1000	1022	14192	1	-5	5
21' 0"	11.51	783	-2186	265	2202	723	-1895	2028	13905	1	-5	5
21' 4"	13.15	894	-2802	30	2803	720	-1896	2028	13889	1	-5	5
22' 0"	11.31	769	-4052	-443	4076	-89	311	323	7759	1	-6	6
23' 0"	12.1	823	-3746	-356	3763	-94	307	321	7718	1	-6	6
24' 7"	11.83	805	-3243	-201	3249	-101	302	319	7667	1	-7	7
26' 3"	11.1	755	-2747	-35	2747	-108	297	316	7619	1	-8	8
27' 11"	10.28	699	-2259	142	2264	-114	293	314	7573	1	-9	9
29' 6"	9.37	637	-1779	329	1810	-119	289	313	7540	1	-9	9
30' 4"	8.26	562	-1545	502	1624	884	194	905	7290	1	-10	10
31' 2"	9.54	648	-1383	-236	1403	879	191	900	7259	1	-10	10
32' 10"	10.85	738	-1071	-1678	1991	876	188	895	7234	1	-11	11
33' 2"	9.91	674	-1003	-1999	2237	-1393	223	1411	4260	1	-11	11
34' 2"	10.22	695	-767	177	788	-75	141	159	3986	1	-12	12
34' 5"	4.5	306	-728	198	754	-78	138	159	3964	1	-12	12
36' 1"	4.52	308	-501	327	598	-84	134	158	3927	2	-13	13
37' 9"	4.12	280	-281	465	543	-87	132	158	3907	2	-14	14
38' 0"	4.01	273	-232	1275	1296	1230	49	1231	3631	2	-14	14
39' 4"	12.82	872	-165	-410	442	1225	45	1226	3603	2	-15	15
40' 9"	10.43	710	-102	-2153	2156	-1315	85	1318	290	2	-16	16
41' 0"	12.04	818	-83	-1864	1866	-1316	84	1319	280	2	-16	16
41' 10"	10.71	728	-1	1	1	1	1	1	7	2	-16	16
42' 7"	0.01	1	0	0	0	0	0	0	0	2	-17	17

**Extreme Wind**

Heights	Stress %	Stress (lb/in <sup>2</sup> )	Moment (ft-lbf)			Force (lbf)				Displacement (in)		
			X	Y	Magnitude	X	Y	Shear Magnitude	Axial	X	Y	Magnitude
0' 0"	5.33	320	1188	-3386	3589	-233	19	234	2968	0	0	0
0' 1"	5.35	321	1189	-3371	3575	-233	21	234	2965	0	0	0
0' 2"	5.34	321	1192	-3340	3547	-233	24	234	2961	0	0	0
0' 4"	5.33	320	1195	-3310	3519	-232	31	234	2950	0	0	0
1' 0"	5.35	321	1216	-3158	3384	-231	44	235	2932	0	0	0
1' 8"	5.26	315	1244	-3006	3253	-230	65	239	2902	0	0	0
3' 3"	5.24	314	1351	-2629	2956	-228	96	247	2859	0	0	0
4' 11"	5.03	302	1508	-2255	2713	-226	125	258	2817	0	0	0
6' 7"	4.89	293	1713	-1885	2548	-224	155	272	2777	0	0	0
8' 2"	5.08	305	1967	-1519	2485	-222	184	288	2738	0	0	0
9' 10"	5.7	342	2269	-1155	2546	-220	212	305	2701	0	0	0
11' 6"	6.61	397	2617	-795	2735	-218	240	324	2665	0	0	0
13' 1"	7.82	469	3010	-438	3042	-216	267	344	2630	0	0	0
14' 9"	9.36	561	3449	-84	3450	-214	294	364	2597	0	0	0
16' 5"	11.22	673	3932	266	3941	-212	321	384	2564	0	0	1
18' 1"	13.41	805	4458	614	4500	-210	347	405	2533	0	0	1
19' 8"	15.52	931	5026	959	5117	-209	369	424	2506	0	1	1
21' 0"	15.62	937	5528	1238	5665	95	-451	461	2448	1	1	1
21' 4"	16.03	962	5381	1208	5515	95	-444	454	2440	1	1	1
22' 0"	15.91	954	5093	1145	5220	96	-427	438	2424	1	1	1
23' 0"	15.56	933	4673	1050	4790	98	-408	419	2402	1	1	1
24' 7"	15.03	902	4005	890	4103	99	-384	396	2376	1	1	1
26' 3"	13.79	827	3376	727	3453	101	-360	374	2351	1	2	2
27' 11"	12.49	749	2784	562	2841	103	-337	353	2326	1	2	2
29' 6"	11.08	665	2231	393	2265	104	-321	337	2309	1	2	2
30' 4"	9.42	565	1973	317	1998	360	-295	465	2276	1	2	3
31' 2"	8.67	520	1726	17	1726	361	-279	456	2259	1	3	3
32' 10"	7.99	479	1269	-575	1393	362	-265	449	2246	1	3	3
33' 2"	6.87	412	1178	-709	1375	-501	-229	551	1107	1	3	3
34' 2"	6.57	394	953	-124	961	-101	-190	215	1070	1	3	3
34' 5"	4.83	290	899	-95	904	-100	-178	204	1058	1	4	4
36' 1"	4.75	285	608	69	612	-99	-157	186	1039	1	4	4
37' 9"	3.59	215	350	231	419	-98	-146	175	1028	1	4	4
38' 0"	2.7	162	312	344	464	302	-105	320	991	1	4	5
39' 4"	3.45	207	168	-70	182	303	-89	316	976	1	5	5
40' 9"	2.64	158	49	-504	506	-401	-50	404	45	1	5	5
41' 0"	3.19	192	38	-416	417	-400	-44	403	40	1	5	5
41' 10"	2.7	162	3	0	3	0	-4	4	4	1	6	6
42' 7"	0.02	1	0	0	0	0	0	0	0	1	6	6

Measured: Proposed

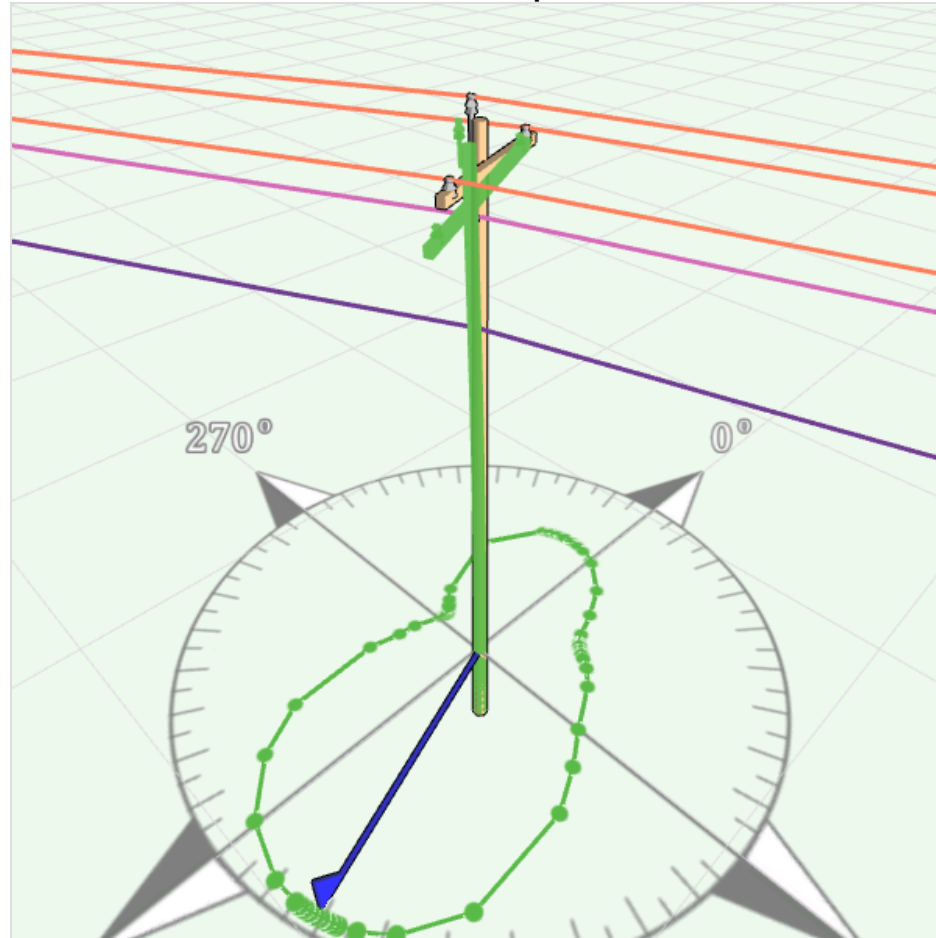

**Design Properties**

**Owner:** Unset Com Owner  
**Species:** Southern Pine  
**Length:** 35'  
**Class:** 5  
**AGL:** 29' 2"  
**GLC:** 29"  
**Foundation:** None  
**Ground Water Level:** None  
**Lean Angle:** 0 °  
**Lean Direction:** 0 °  
**Capacity Adjustment:** 100%  
**Effective Allowable Stress:** 8000 lb/in<sup>2</sup>  
**GPS Location:** Undefined.  
**Map Location:** 38.94244471833346 , -91.21483041483972

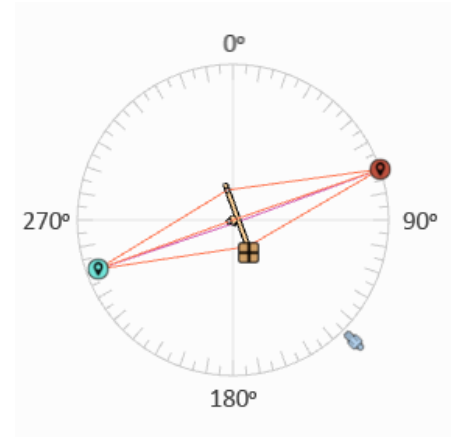
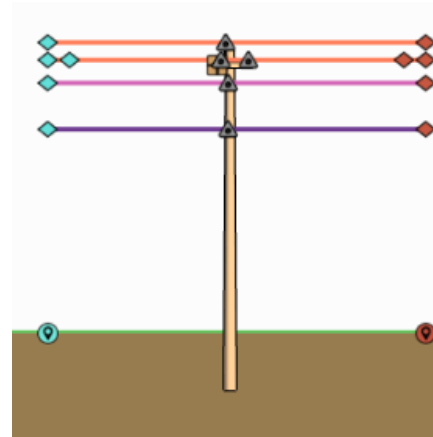

**Load Case Properties**

	Heavy Grade C (Governing Case)	Extreme Wind
LoadCase Type	NESC 2012 Heavy	NESC Extreme Wind 2012
Construction Grade	C	B
Construction Type	New	New
Temperature	0 °F	60 °F
Wind Pressure	4 lb/ft <sup>2</sup>	90 mph
Ice Thickness	0.5"	0"
Wind	Sweep	Sweep
Wind Direction	0 °	0 °
Wind Increment	1 °	1 °
Analysis Method	Basic (Direct Stiffness)	Basic (Direct Stiffness)
Load Percentage Allowed	100%	100%
Average Length on Main Span	No	No
Displacement Based Load Changes	None	None
Analyze Ground Line Only	No	No
Analyze with Buckling Case	No	No
Analyze with Deflection Case	No	No
Analyze with Strength Results	No	No
Custom	No	No

**Analysis Results**

**Loading**

Component	Heavy Grade C (Governing Case)			Extreme Wind			Client File Maximum Rating
	Max %	Load (Applied / Allowable)	Wind Direction	Max %	Load (Applied / Allowable)	Wind Direction	
Pole - Stress	77.93 from stress	5299 lb/in <sup>2</sup> / 6800 lb/in <sup>2</sup>	161 °	23.56 from stress	1413 lb/in <sup>2</sup> / 6000 lb/in <sup>2</sup>	96 °	8000 lb/in <sup>2</sup>
Wood 8 Ft 4 x 5 (SYP) [27' 7"] (CrossArm#1) - Stress	13.59	-855 lb/in <sup>2</sup> / 6290 lb/in <sup>2</sup>	162 °	2.9	-161 lb/in <sup>2</sup> / 5550 lb/in <sup>2</sup>	246 °	7400 lb/in <sup>2</sup>
24.9 kV Pin Type Insulator (Crossarm) [0' 8"] (Insulator#1) - Force	7.2	360 lbf / 5000 lbf	161 °	0.68	34 lbf / 5000 lbf	161 °	5000 lbf
24.9 kV Pin Type Insulator (Crossarm) [7' 4"] (Insulator#2) - Force	7.2	360 lbf / 5000 lbf	161 °	0.68	34 lbf / 5000 lbf	160 °	5000 lbf
3" Spool Bolt [25' 9"] (Insulator#3) - Force	10.76	323 lbf / 3000 lbf	161 °	0.83	25 lbf / 3000 lbf	161 °	3000 lbf
24.9 kV Pin Type Insulator (Pole Top) [28' 4"] (Insulator#4) - Force	7.2	360 lbf / 5000 lbf	161 °	0.7	35 lbf / 5000 lbf	161 °	5000 lbf
Comm 3 Bolt Clamp [21' 0"] (Insulator#5) - Force	20.59	618 lbf / 3000 lbf	161 °	2.99	90 lbf / 3000 lbf	185 °	3000 lbf
Proposed Fiber 1", Full (ProposedWire#2) - Tension	21.71	2431 lbf / 6720 lbf	N/A	N/A	N/A	N/A	11200 lbf
1/0 ACSR, Full (Wire#4) - Tension	45.49	1992 lbf / 2628 lbf	N/A	N/A	N/A	N/A	4380 lbf

Pole Analysis Charts for Governing Load Case: Heavy Grade C

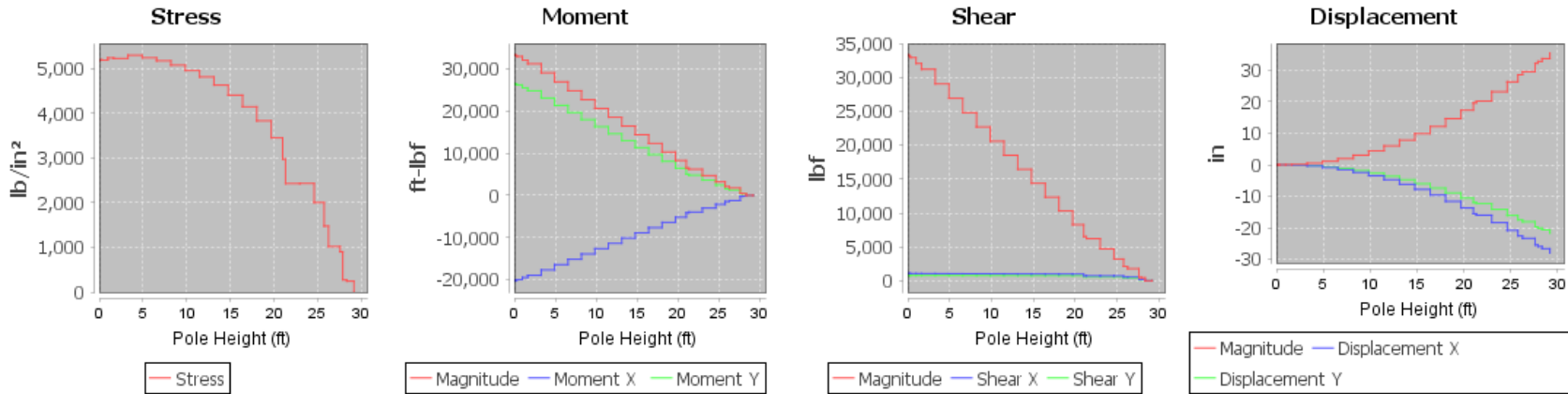

Pole Static Analysis

Heavy Grade C

Heights	Stress %	Stress (lb/in <sup>2</sup> )	Moment (ft-lbf)			Force (lbf)				Displacement (in)		
			X	Y	Magnitude	X	Y	Shear Magnitude	Axial	X	Y	Magnitude
0'0"	76.15	5178	-20245	26567	33402	1067	782	1323	2406	0	0	0
0'1"	76.35	5192	-20194	26497	33315	1067	782	1323	2403	0	0	0
0'2"	76.37	5193	-20091	26357	33141	1066	781	1322	2398	0	0	0
0'4"	76.32	5190	-19989	26217	32968	1064	781	1320	2385	0	0	0
1'0"	77.06	5240	-19477	25518	32102	1061	780	1317	2362	0	0	0
1'8"	76.87	5227	-18965	24822	31238	1055	778	1311	2325	0	0	0
3'3"	77.93	5299	-17689	23092	29088	1047	775	1303	2272	0	0	0
4'11"	77.09	5242	-16418	21374	26952	1039	772	1295	2222	-1	-1	1
6'7"	76.1	5175	-15151	19669	24828	1031	770	1287	2174	-2	-1	2
8'2"	74.67	5078	-13889	17977	22717	1024	767	1279	2127	-2	-2	3
9'10"	72.88	4956	-12631	16298	20619	1016	764	1272	2083	-3	-3	4
11'6"	70.78	4813	-11377	14630	18533	1009	762	1265	2041	-5	-4	6
13'1"	68.07	4629	-10127	12975	16459	1002	759	1257	2000	-6	-5	8
14'9"	64.79	4406	-8881	11330	14396	995	757	1251	1961	-8	-6	10
16'5"	60.96	4146	-7639	9698	12345	989	755	1244	1925	-10	-7	12
18'1"	56.35	3832	-6401	8076	10305	982	753	1237	1890	-12	-9	15
19'8"	50.73	3450	-5167	6465	8276	976	751	1231	1859	-14	-11	17
21'0"	43.72	2973	-4127	5036	6511	728	564	921	1307	-16	-12	20
21'4"	35.71	2428	-3943	4799	6211	724	563	917	1288	-16	-12	20
23'0"	35.75	2431	-3019	3611	4707	718	561	911	1258	-18	-14	23
24'7"	29.45	2002	-2099	2432	3213	713	559	906	1234	-21	-16	26
25'9"	21.7	1475	-1437	1554	2117	549	429	696	973	-23	-17	29
26'3"	14.99	1019	-1224	1282	1772	545	428	693	958	-23	-18	30
27'7"	13.22	899	-242	454	514	185	143	234	302	-25	-20	32
27'11"	4.02	273	-199	398	445	183	143	232	296	-26	-20	33
28'4"	3.56	242	0	1	1	1	0	1	6	-27	-21	34
29'2"	0.01	1	0	0	0	0	0	0	0	-28	-22	35



**Extreme Wind**

Heights	Stress %	Stress (lb/in <sup>2</sup> )	Moment (ft-lbf)			Force (lbf)				Displacement (in)		
			X	Y	Magnitude	X	Y	Shear Magnitude	Axial	X	Y	Magnitude
0' 0"	23.38	1403	-8760	2319	9061	104	495	506	616	0	0	0
0' 1"	23.46	1408	-8727	2312	9028	104	494	505	614	0	0	0
0' 2"	23.45	1407	-8662	2298	8962	104	492	503	612	0	0	0
0' 4"	23.38	1403	-8598	2284	8896	104	486	497	605	0	0	0
1' 0"	23.56	1413	-8279	2216	8570	103	477	488	593	0	0	0
1' 8"	23.25	1395	-7966	2149	8251	101	461	471	573	0	0	0
3' 3"	23.32	1399	-7210	1984	7478	98	437	448	546	0	0	0
4' 11"	22.45	1347	-6493	1822	6743	96	415	426	519	0	0	0
6' 7"	21.57	1294	-5812	1665	6046	94	393	404	494	0	0	1
8' 2"	20.6	1236	-5167	1511	5384	91	371	382	469	0	-1	1
9' 10"	19.56	1174	-4558	1361	4757	89	350	361	446	0	-1	1
11' 6"	18.5	1110	-3984	1215	4165	87	329	341	424	0	-1	2
13' 1"	17.33	1040	-3444	1072	3607	85	309	321	402	-1	-2	2
14' 9"	16.08	965	-2937	933	3081	83	289	301	382	-1	-2	2
16' 5"	14.77	886	-2462	797	2588	81	270	282	363	-1	-3	3
18' 1"	13.37	802	-2019	664	2125	79	251	263	344	-1	-3	4
19' 8"	11.84	710	-1607	535	1693	77	235	247	328	-1	-4	4
21' 0"	10.11	607	-1289	409	1353	62	218	227	232	-1	-5	5
21' 4"	8.39	503	-1218	389	1279	61	207	216	222	-1	-5	5
23' 0"	8.32	499	-878	289	924	59	190	199	206	-2	-5	6
24' 7"	6.53	392	-566	191	597	58	176	185	193	-2	-6	6
25' 9"	4.55	273	-363	119	382	50	163	171	163	-2	-7	7
26' 3"	3.06	184	-282	95	297	49	154	162	155	-2	-7	7
27' 7"	2.51	151	-26	33	41	14	27	30	43	-2	-7	8
27' 11"	0.38	23	-17	28	33	13	23	27	39	-2	-8	8
28' 4"	0.31	19	-3	0	3	0	4	4	3	-2	-8	8
29' 2"	0.03	2	0	0	0	0	0	0	0	-2	-8	8

Measured: Proposed

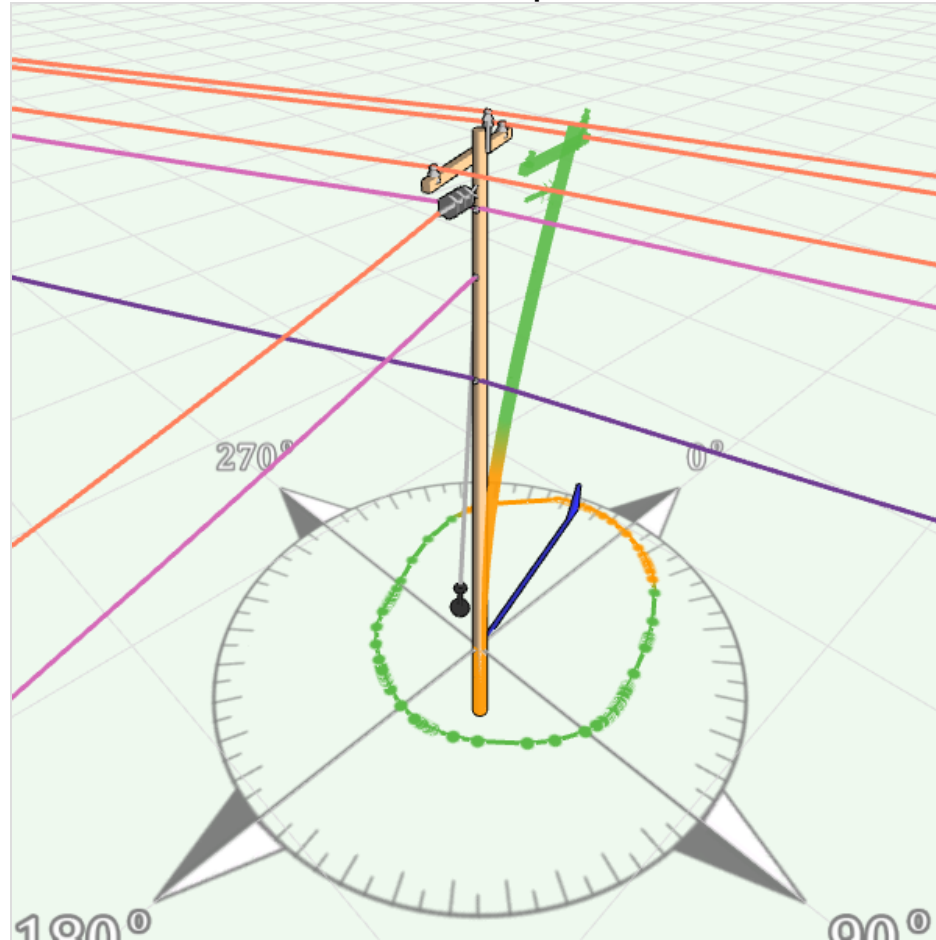

**Design Properties**

**Owner:** Unset Com Owner  
**Species:** Southern Pine  
**Length:** 40'  
**Class:** 4  
**AGL:** 32' 11"  
**GLC:** 33"  
**Foundation:** None  
**Ground Water Level:** None  
**Lean Angle:** 0 °  
**Lean Direction:** 0 °  
**Capacity Adjustment:** 100%  
**Effective Allowable Stress:** 8000 lb/in<sup>2</sup>  
**GPS Location:** 38.942633998860146 , -91.21411017457791  
**Map Location:** 38.94263742563179 , -91.21411083835949

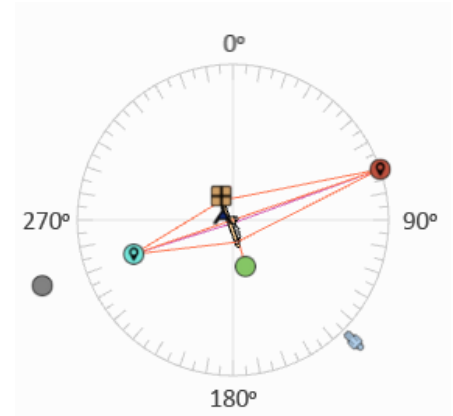
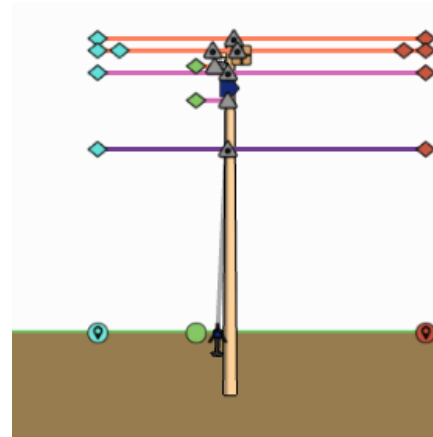

**Design Warnings**

Type	Description
Analysis Near Capacity	F1-2 [5' 0", 300 °] loading for Heavy Grade C - 99.18 %

**Load Case Properties**

	Heavy Grade C (Governing Case)	Extreme Wind
LoadCase Type	NESC 2012 Heavy	NESC Extreme Wind 2012
Construction Grade	C	B
Construction Type	New	New
Temperature	0 °F	60 °F
Wind Pressure	4 lb/ft <sup>2</sup>	90 mph
Ice Thickness	0.5"	0"
Wind	Sweep	Sweep
Wind Direction	0 °	0 °
Wind Increment	1 °	1 °
Analysis Method	Basic (Direct Stiffness)	Basic (Direct Stiffness)
Load Percentage Allowed	100%	100%
Average Length on Main Span	No	No
Displacement Based Load Changes	None	None
Analyze Ground Line Only	No	No
Analyze with Buckling Case	No	No
Analyze with Deflection Case	No	No
Analyze with Strength Results	No	No
Custom	No	No

### Analysis Results

#### Loading

Component	Heavy Grade C (Governing Case)			Extreme Wind			Client File Maximum Rating
	Max %	Load (Applied / Allowable)	Wind Direction	Max %	Load (Applied / Allowable)	Wind Direction	
Pole - Stress	96.04 from stress	6531 lb/in <sup>2</sup> / 6800 lb/in <sup>2</sup>	344 °	27.92 from stress	1675 lb/in <sup>2</sup> / 6000 lb/in <sup>2</sup>	43 °	8000 lb/in <sup>2</sup>
Wood 8 Ft 4 x 5 (SYP) [31' 9"] (CrossArm#1) - Stress	25.26	-1589 lb/in <sup>2</sup> / 6290 lb/in <sup>2</sup>	160 °	2.98	165 lb/in <sup>2</sup> / 5550 lb/in <sup>2</sup>	69 °	7400 lb/in <sup>2</sup>
24.9 kV Pin Type Insulator (Crossarm) [0' 8"] (Insulator#1) - Force	11.55	578 lbf / 5000 lbf	163 °	0.64	32 lbf / 5000 lbf	162 °	5000 lbf
24.9 kV Pin Type Insulator (Crossarm) [7' 4"] (Insulator#2) - Force	11.69	584 lbf / 5000 lbf	341 °	0.72	36 lbf / 5000 lbf	341 °	5000 lbf
24.9 kV Pin Type Insulator (Pole Top) [32' 1"] (Insulator#3) - Force	10.87	543 lbf / 5000 lbf	162 °	0.49	24 lbf / 5000 lbf	161 °	5000 lbf
24.9 kV Dead End Insulator [30' 6"] (Insulator#4) - Force	10.48	524 lbf / 5000 lbf	75 °	0.62	31 lbf / 5000 lbf	212 °	5000 lbf
3" Spool Bolt [26' 7"] (Insulator#5) - Force	17.47	524 lbf / 3000 lbf	75 °	0.99	30 lbf / 3000 lbf	165 °	3000 lbf
3" Spool Bolt [29' 9"] (Insulator#6) - Force	17.93	538 lbf / 3000 lbf	161 °	0.98	29 lbf / 3000 lbf	161 °	3000 lbf
Comm 3 Bolt Clamp [21' 0"] (Insulator#7) - Force	41.88	1256 lbf / 3000 lbf	341 °	13.39	402 lbf / 3000 lbf	49 °	3000 lbf
Proposed Fiber 1", Full (ProposedWire#1) - Tension	28.57	3200 lbf / 6720 lbf	N/A	N/A	N/A	N/A	11200 lbf
1/0 ACSR, Full (Wire#1) - Tension	53.04	2323 lbf / 2628 lbf	N/A	N/A	N/A	N/A	4380 lbf
3/8" EHS [28' 0"] (Guy#1) - Force	89.45	12398 lbf / 13860 lbf	159 °	15.39	2133 lbf / 13860 lbf	106 °	15400 lbf
F1-2 [5' 0", 300 °] (Anchor#1) - Force	99.18	12398 lbf / 12500 lbf	159 °	17.06	2133 lbf / 12500 lbf	106 °	12500 lbf

#### Pole Analysis Charts for Governing Load Case: Heavy Grade C

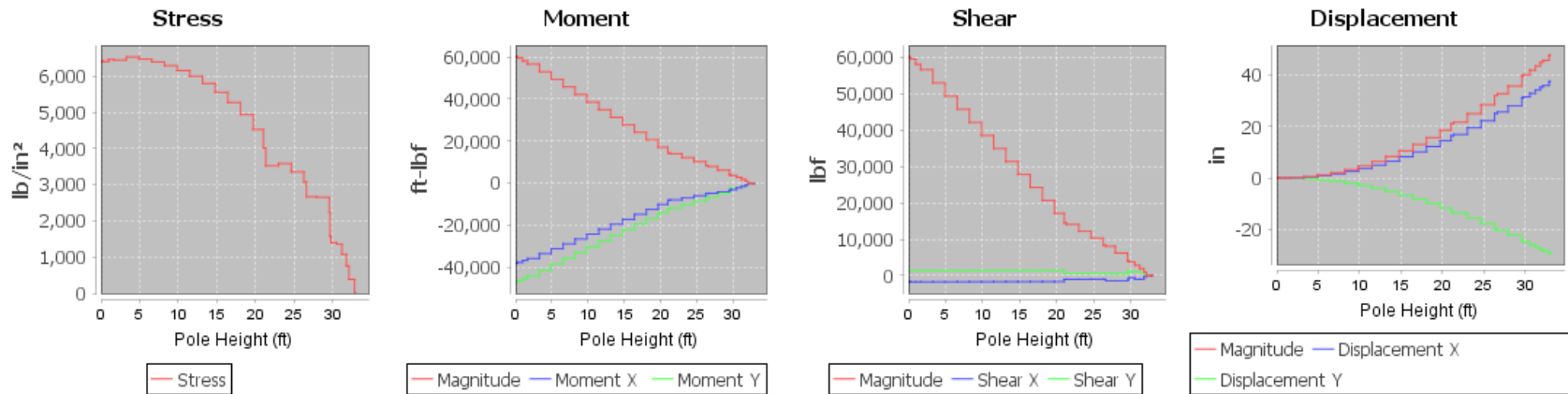

#### Pole Static Analysis

Heavy Grade C

Heights	Stress %	Stress (lb/in <sup>2</sup> )	Moment (ft-lbf)			Force (lbf)				Displacement (in)		
			X	Y	Magnitude	X	Y	Shear Magnitude	Axial	X	Y	Magnitude
0' 0"	93.95	6388	-37962	-46739	60213	-1721	1405	2222	8853	0	0	0
0' 1"	94.17	6404	-37869	-46626	60067	-1721	1405	2222	8848	0	0	0
0' 2"	94.21	6406	-37685	-46400	59776	-1720	1406	2221	8842	0	0	0
0' 4"	94.15	6402	-37501	-46175	59484	-1718	1406	2220	8825	0	0	0
1' 0"	95	6460	-36578	-45048	58028	-1714	1407	2218	8796	0	0	0
1' 8"	94.8	6446	-35654	-43923	56573	-1707	1409	2214	8747	0	0	0
3' 3"	96.04	6531	-33343	-41123	52942	-1698	1412	2208	8679	0	0	1
4' 11"	95.13	6469	-31027	-38338	49320	-1689	1415	2203	8613	1	-1	1
6' 7"	94.06	6396	-28706	-35568	45707	-1680	1417	2198	8550	2	-1	2
8' 2"	92.49	6289	-26381	-32812	42103	-1671	1420	2192	8489	3	-2	3
9' 10"	90.52	6155	-24053	-30071	38507	-1662	1422	2188	8430	4	-3	5
11' 6"	88.22	5999	-21720	-27345	34921	-1654	1425	2183	8374	5	-4	6
13' 1"	85.26	5798	-19383	-24632	31344	-1645	1427	2178	8321	7	-5	8
14' 9"	81.68	5554	-17042	-21933	27776	-1637	1429	2173	8269	8	-7	11
16' 5"	77.53	5272	-14698	-19247	24217	-1629	1432	2169	8220	10	-8	13
18' 1"	72.57	4935	-12349	-16574	20669	-1622	1434	2165	8173	12	-10	16
19' 8"	66.54	4525	-9998	-13913	17133	-1615	1436	2161	8132	15	-12	19
21' 0"	59.04	4014	-8037	-12015	14455	-988	602	1157	7408	16	-13	21
21' 4"	51.77	3521	-7841	-11693	14079	-984	604	1154	7383	17	-14	22
23' 0"	52.7	3584	-6850	-10080	12187	-977	606	1149	7342	20	-16	25
24' 7"	49.31	3353	-5856	-8478	10304	-969	608	1144	7303	22	-18	28
26' 3"	45.22	3075	-4859	-6887	8429	-965	609	1141	7280	25	-20	32
26' 7"	39.17	2664	-4650	-6578	8056	-1400	493	1484	7209	26	-20	33
27' 11"	39.01	2652	-4007	-4753	6217	-1394	494	1479	7178	28	-22	36
29' 6"	32.84	2233	-3196	-2467	4038	-1390	495	1476	7160	31	-25	40
29' 8"	23.18	1576	-3148	-2333	3918	-858	1413	1653	1386	31	-25	40
29' 9"	20.53	1396	-2945	-2315	3746	-536	1119	1241	1062	32	-25	40
30' 6"	19.94	1356	-2102	-1929	2852	-971	1003	1395	995	33	-26	42
31' 2"	15.81	1075	-1432	-1280	1921	-968	1003	1394	983	34	-27	44
31' 9"	11.11	755	-723	-644	969	-324	332	464	267	35	-28	45
32' 1"	5.64	384	0	-1	1	-2	-1	2	9	36	-28	46
32' 10"	0.01	1	0	0	0	0	0	0	1	37	-29	48
32' 11"	0	0	0	0	0	0	0	0	0	38	-30	48

Extreme Wind

Heights	Stress %	Stress (lb/in <sup>2</sup> )	Moment (ft-lbf)			Force (lbf)				Displacement (in)		
			X	Y	Magnitude	X	Y	Shear Magnitude	Axial	X	Y	Magnitude
0' 0"	27.73	1664	-10582	-11655	15742	-586	606	843	1924	0	0	0
0' 1"	27.83	1670	-10543	-11616	15687	-585	605	842	1922	0	0	0
0' 2"	27.81	1669	-10463	-11540	15577	-584	603	839	1919	0	0	0
0' 4"	27.73	1664	-10384	-11463	15467	-579	599	833	1909	0	0	0
1' 0"	27.92	1675	-9991	-11083	14922	-571	591	822	1894	0	0	0
1' 8"	27.56	1653	-9603	-10708	14384	-557	579	803	1868	0	0	0
3' 3"	27.6	1656	-8654	-9794	13070	-538	561	777	1832	0	0	0
4' 11"	26.55	1593	-7734	-8912	11800	-519	543	751	1798	0	0	0
6' 7"	25.45	1527	-6843	-8061	10574	-500	526	726	1764	0	0	1
8' 2"	24.2	1452	-5981	-7240	9391	-482	509	701	1732	1	-1	1
9' 10"	22.84	1371	-5147	-6449	8251	-464	492	676	1702	1	-1	1
11' 6"	21.4	1284	-4340	-5687	7154	-447	476	653	1672	1	-1	2
13' 1"	19.78	1187	-3559	-4954	6100	-430	460	629	1644	2	-1	2
14' 9"	18.02	1081	-2805	-4249	5092	-413	444	606	1617	2	-2	3
16' 5"	16.14	968	-2077	-3572	4132	-396	429	584	1591	2	-2	3
18' 1"	14.09	845	-1373	-2922	3228	-380	414	562	1566	3	-2	4
19' 8"	11.87	712	-694	-2298	2400	-366	401	543	1545	3	-3	4
21' 0"	9.5	570	-156	-1853	1859	-231	31	233	1418	4	-3	5
21' 4"	7.7	462	-146	-1778	1784	-222	22	223	1404	4	-3	5
23' 0"	7.73	464	-109	-1414	1418	-207	8	207	1383	4	-4	6
24' 7"	6.69	401	-95	-1075	1080	-192	-5	192	1362	5	-4	6
26' 3"	5.59	335	-104	-760	767	-183	-13	184	1350	5	-4	7
26' 7"	4.3	258	-108	-700	708	-202	-28	204	1336	6	-4	7
27' 11"	4.16	250	-144	-436	459	-190	-40	194	1320	6	-5	8
29' 6"	3.07	184	-209	-124	243	-183	-46	189	1310	7	-5	8
29' 8"	1.95	117	-225	-116	253	-74	123	143	196	7	-5	8
29' 9"	1.55	93	-207	-115	237	-69	119	137	162	7	-5	8
30' 6"	1.47	88	-118	-65	134	-87	103	135	151	7	-5	9
31' 2"	0.89	53	-49	-6	49	-82	98	128	145	7	-6	9
31' 9"	0.38	23	-23	-5	24	-9	15	18	32	7	-6	9
32' 1"	0.17	10	-3	-3	4	-4	3	5	5	8	-6	10
32' 10"	0.03	2	0	0	0	0	0	1	1	8	-6	10
32' 11"	0	0	0	0	0	0	0	0	0	8	-6	10

Measured: Proposed

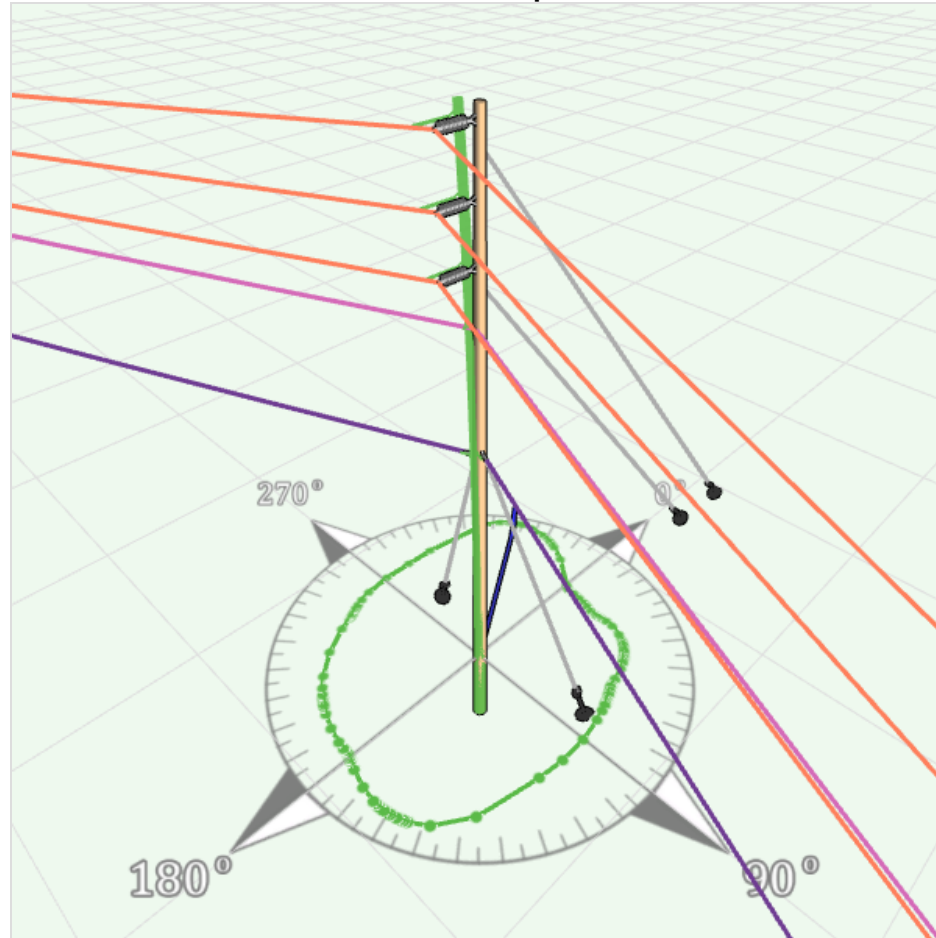

**Design Properties**

**Owner:** Unset Com Owner  
**Species:** Southern Pine  
**Length:** 50'  
**Class:** 4  
**AGL:** 42' 7"  
**GLC:** 37 1/4"  
**Foundation:** None  
**Ground Water Level:** None  
**Lean Angle:** 0 °  
**Lean Direction:** 0 °  
**Capacity Adjustment:** 100%  
**Effective Allowable Stress:** 8000 lb/in<sup>2</sup>  
**GPS Location:** 38.94293810436353 , -91.21303825571123  
**Map Location:** 38.94292792604157 , -91.21304548018888

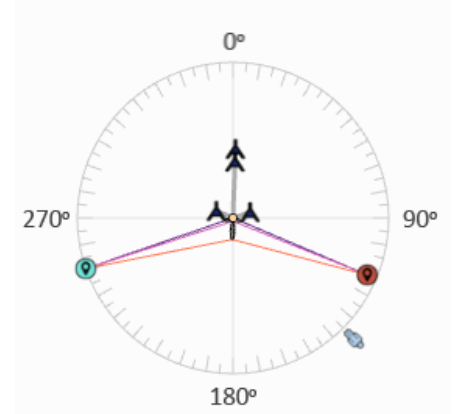
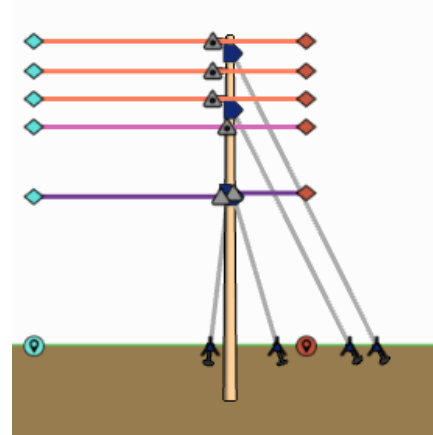

**Load Case Properties**

	Heavy Grade C (Governing Case)	Extreme Wind
LoadCase Type	NESC 2012 Heavy	NESC Extreme Wind 2012
Construction Grade	C	B
Construction Type	New	New
Temperature	0 °F	60 °F
Wind Pressure	4 lb/ft <sup>2</sup>	90 mph
Ice Thickness	0.5"	0"
Wind	Sweep	Sweep
Wind Direction	0 °	0 °
Wind Increment	1 °	1 °
Analysis Method	Basic (Direct Stiffness)	Basic (Direct Stiffness)
Load Percentage Allowed	100%	100%
Average Length on Main Span	No	No
Displacement Based Load Changes	None	None
Analyze Ground Line Only	No	No
Analyze with Buckling Case	No	No
Analyze with Deflection Case	No	No
Analyze with Strength Results	No	No
Custom	No	No



### Analysis Results

#### Loading

Component	Heavy Grade C (Governing Case)			Extreme Wind			Client File Maximum Rating
	Max %	Load (Applied / Allowable)	Wind Direction	Max %	Load (Applied / Allowable)	Wind Direction	
Pole - Stress	39.18 from stress	2664 lb/in <sup>2</sup> / 6800 lb/in <sup>2</sup>	327 °	13.57 from stress	814 lb/in <sup>2</sup> / 6000 lb/in <sup>2</sup>	104 °	8000 lb/in <sup>2</sup>
3" Spool Bolt [30' 1"] (Insulator#1) - Force	63.87	1916 lbf / 3000 lbf	180 °	10.54	316 lbf / 3000 lbf	182 °	3000 lbf
24.9 kV Running Angle Insulator [33' 11"] (Insulator#2) - Force	47.39	2369 lbf / 5000 lbf	180 °	9.96	498 lbf / 5000 lbf	220 °	5000 lbf
24.9 kV Running Angle Insulator [37' 9"] (Insulator#3) - Force	45.79	2289 lbf / 5000 lbf	180 °	9.47	473 lbf / 5000 lbf	144 °	5000 lbf
24.9 kV Running Angle Insulator [41' 10"] (Insulator#4) - Force	47.24	2362 lbf / 5000 lbf	180 °	9.78	489 lbf / 5000 lbf	144 °	5000 lbf
Comm D/E Bolt [20' 6"] (Insulator#5) - Force	59.52	4167 lbf / 7000 lbf	161 °	18.17	1272 lbf / 7000 lbf	206 °	7000 lbf
Comm D/E Bolt [21' 0"] (Insulator#6) - Force	58.07	4065 lbf / 7000 lbf	23 °	18.16	1271 lbf / 7000 lbf	68 °	7000 lbf
Proposed Fiber 1", Full (ProposedWire#1) - Tension	28.57	3200 lbf / 6720 lbf	N/A	N/A	N/A	N/A	11200 lbf
1/0 ACSR, Full (Wire#6) - Tension	53.04	2323 lbf / 2628 lbf	N/A	N/A	N/A	N/A	4380 lbf
1/4" EHS [21' 0"] (DownGuy#1) - Force	35.93	2151 lbf / 5985 lbf	39 °	26.51	1587 lbf / 5985 lbf	94 °	6650 lbf
1/4" EHS [20' 6"] (DownGuy#2) - Force	63.02	3772 lbf / 5985 lbf	326 °	23.92	1432 lbf / 5985 lbf	270 °	6650 lbf
3/8" EHS [32' 5"] (Guy#1) - Force	53.51	7417 lbf / 13860 lbf	181 °	16.57	2296 lbf / 13860 lbf	183 °	15400 lbf
3/8" EHS [40' 2"] (Guy#2) - Force	43.14	5979 lbf / 13860 lbf	181 °	10.75	1489 lbf / 13860 lbf	182 °	15400 lbf
Proposed Anchor [8' 0", 293 °] (Anchor#1) - Force	30.72	2151 lbf / 7000 lbf	39 °	22.67	1587 lbf / 7000 lbf	94 °	7000 lbf
Proposed Anchor [8' 0", 71 °] (Anchor#2) - Force	53.88	3772 lbf / 7000 lbf	326 °	20.45	1432 lbf / 7000 lbf	270 °	7000 lbf
F1-2 [26' 0", 2 °] (Anchor#3) - Force	59.34	7417 lbf / 12500 lbf	181 °	18.37	2296 lbf / 12500 lbf	183 °	12500 lbf
F1-2 [32' 0", 2 °] (Anchor#4) - Force	47.83	5979 lbf / 12500 lbf	181 °	11.91	1489 lbf / 12500 lbf	182 °	12500 lbf

#### Pole Analysis Charts for Governing Load Case: Heavy Grade C

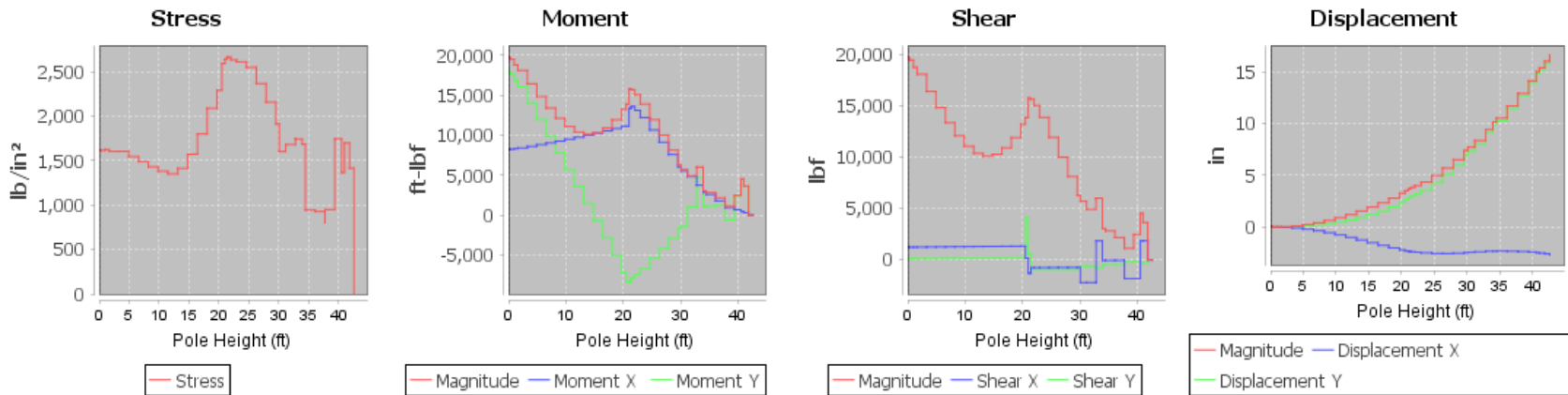

#### Pole Static Analysis

Heavy Grade C

Heights	Stress %	Stress (lb/in <sup>2</sup> )	Moment (ft-lbf)			Force (lbf)				Displacement (in)		
			X	Y	Magnitude	X	Y	Shear Magnitude	Axial	X	Y	Magnitude
0' 0"	23.75	1615	8198	18046	19820	1227	114	1233	18228	0	0	0
0' 1"	23.83	1620	8205	17965	19750	1228	114	1233	18222	0	0	0
0' 2"	23.81	1619	8220	17804	19610	1229	115	1234	18215	0	0	0
0' 4"	23.75	1615	8235	17643	19470	1231	116	1236	18193	0	0	0
1' 0"	23.89	1624	8311	16835	18775	1235	119	1240	18156	0	0	0
1' 8"	23.58	1604	8389	16025	18088	1241	123	1247	18094	0	0	0
3' 3"	23.59	1604	8591	13989	16416	1250	129	1257	18007	0	0	0
4' 11"	22.73	1546	8802	11938	14832	1259	135	1267	17923	0	0	0
6' 7"	21.88	1488	9023	9872	13374	1268	140	1276	17842	0	0	0
8' 2"	21.03	1430	9253	7791	12096	1277	146	1285	17763	-1	0	1
9' 10"	20.31	1381	9492	5696	11070	1286	152	1294	17688	-1	0	1
11' 6"	19.86	1351	9741	3587	10380	1294	157	1303	17616	-1	1	1
13' 1"	20.77	1413	9999	1465	10105	1302	162	1312	17546	-1	1	2
14' 9"	23.12	1572	10265	-671	10287	1310	168	1321	17478	-2	1	2
16' 5"	26.45	1798	10540	-2821	10911	1318	173	1329	17414	-2	2	2
18' 1"	30.71	2089	10823	-4983	11915	1326	178	1338	17352	-2	2	3
19' 8"	33.69	2291	11115	-7158	13221	1332	182	1344	17307	-2	2	3
20' 6"	38.11	2592	11113	-8295	13868	1355	187	1350	17247	-2	3	4
21' 0"	38.81	2639	13320	-8432	15764	-1301	552	1413	16474	-2	3	4
21' 4"	39.12	2660	13500	-8008	15696	-1300	552	1413	16465	-2	3	4
21' 6"	39.18	2664	13591	-7799	15669	-780	-949	1228	12430	-2	3	4
22' 0"	38.73	2634	13100	-7396	15044	-775	-946	1223	12402	-2	3	4
23' 0"	38.39	2611	12191	-6651	13887	-769	-942	1216	12359	-2	4	4
24' 7"	37.5	2550	10645	-5389	11932	-762	-937	1208	12307	-3	4	5
26' 3"	34.8	2366	9107	-4138	10004	-755	-933	1200	12258	-3	5	6
27' 11"	31.72	2157	7577	-2899	8113	-749	-929	1193	12210	-3	6	7
29' 6"	28.13	1913	6054	-1671	6280	-744	-926	1188	12179	-2	7	7
30' 1"	23.55	1601	5534	-1402	5709	-2227	-653	2321	11735	-2	7	8
31' 2"	24.7	1680	4826	1014	4931	-2222	-650	2315	11699	-2	8	8
32' 10"	25.7	1748	3760	4658	5986	-2218	-648	2311	11678	-2	9	9
32' 10"	25.62	1742	3750	4698	6011	1845	-786	2006	6622	-2	9	9
33' 11"	24.78	1685	2837	1095	3041	-61	-480	484	6084	-2	10	10
34' 5"	13.86	942	2582	1127	2817	-57	-477	480	6058	-2	10	11
36' 1"	13.63	927	1799	1220	2174	-51	-473	476	6021	-2	11	12
37' 9"	11.82	804	1023	1303	1657	-48	-471	474	6003	-2	13	13
37' 9"	13.96	950	947	-594	1118	-1836	-177	1844	5363	-2	13	13
39' 4"	25.66	1745	661	2379	2469	-1831	-174	1839	5334	-2	14	14
40' 6"	20.09	1366	460	4504	4527	1844	-297	1868	727	-2	15	15
41' 0"	24.98	1699	317	3617	3631	1846	-296	1870	715	-3	15	15
41' 10"	20.8	1415	1	-1	1	-1	-1	1	7	-3	16	16
42' 7"	0.01	1	0	0	0	0	0	0	0	-3	16	17

Extreme Wind

Heights	Stress %	Stress (lb/in <sup>2</sup> )	Moment (ft-lbf)			Force (lbf)				Displacement (in)		
			X	Y	Magnitude	X	Y	Shear Magnitude	Axial	X	Y	Magnitude
0' 0"	10.5	630	-3748	7032	7968	534	174	562	5259	0	0	0
0' 1"	10.54	633	-3736	6996	7932	534	172	561	5256	0	0	0
0' 2"	10.53	632	-3714	6926	7859	533	170	560	5252	0	0	0
0' 4"	10.48	629	-3692	6856	7787	531	162	555	5240	0	0	0
1' 0"	10.52	631	-3585	6508	7430	528	149	549	5221	0	0	0
1' 8"	10.27	616	-3487	6161	7080	523	128	538	5188	0	0	0
3' 3"	10.16	610	-3278	5304	6235	515	97	524	5143	0	0	0
4' 11"	9.51	570	-3118	4458	5441	508	67	512	5098	0	0	0
6' 7"	8.85	531	-3008	3626	4711	500	38	502	5056	0	0	0
8' 2"	8.18	491	-2946	2805	4068	493	9	493	5014	0	0	0
9' 10"	7.56	454	-2932	1996	3547	486	-20	486	4975	0	0	0
11' 6"	7.08	425	-2964	1199	3197	479	-48	481	4937	0	0	0
13' 1"	7.18	431	-3042	413	3070	472	-75	478	4900	0	0	1
14' 9"	8.28	497	-3165	-362	3186	466	-102	477	4864	-1	0	1
16' 5"	9.86	591	-3333	-1126	3518	459	-128	477	4830	-1	-1	1
18' 1"	11.85	711	-3543	-1879	4010	453	-154	478	4798	-1	-1	1
19' 8"	13.19	792	-3796	-2621	4613	448	-173	480	4774	-1	-1	1
20' 6"	12.61	757	-3961	-2995	4966	31	1016	1016	4695	-1	-1	1
21' 0"	13.57	814	-3430	-3020	4570	-466	-160	492	4622	-1	-1	1
21' 4"	12.76	766	-3482	-2868	4511	-467	-163	494	4618	-1	-1	1
21' 6"	12.74	764	-3513	-2791	4487	-469	-173	500	4610	-1	-1	1
22' 0"	12.83	770	-3607	-2547	4416	-253	329	415	3139	-1	-1	1
23' 0"	12.64	759	-3290	-2304	4017	-258	310	403	3116	-1	-1	2
24' 7"	12.17	730	-2781	-1881	3358	-264	287	390	3089	-1	-1	2
26' 3"	10.99	660	-2311	-1449	2728	-269	264	377	3063	-1	-2	2
27' 11"	9.72	583	-1879	-1007	2131	-275	241	366	3038	-1	-2	2
29' 6"	8.33	500	-1483	-555	1584	-279	226	359	3021	-1	-2	2
30' 1"	6.72	403	-1358	-415	1420	-594	224	635	2968	-1	-2	3
31' 2"	6.77	406	-1115	230	1138	-598	207	633	2950	-1	-3	3
32' 10"	7.05	423	-776	1211	1438	-601	196	632	2938	-1	-3	3
32' 10"	7.02	421	-778	1225	1451	587	135	603	1446	-1	-3	3
33' 11"	6.72	403	-638	392	749	91	132	160	1373	-1	-3	3
34' 5"	3.82	229	-567	344	663	88	119	148	1360	-1	-3	3
36' 1"	3.61	217	-373	200	423	83	99	129	1340	-1	-4	4
37' 9"	2.67	160	-211	64	220	80	89	120	1331	-1	-4	4
37' 9"	3.02	181	-218	-180	282	-388	86	397	1242	-1	-4	4
39' 4"	5.87	352	-79	449	455	-392	70	398	1227	-1	-4	4
40' 6"	4.21	253	-4	906	906	485	13	485	109	-1	-5	5
41' 0"	5.65	339	2	673	673	483	6	483	102	-1	-5	5
41' 10"	4.36	261	-3	1	3	1	4	4	4	-1	-5	5
42' 7"	0.02	1	0	0	0	0	0	0	0	-1	-5	5

Measured: Proposed

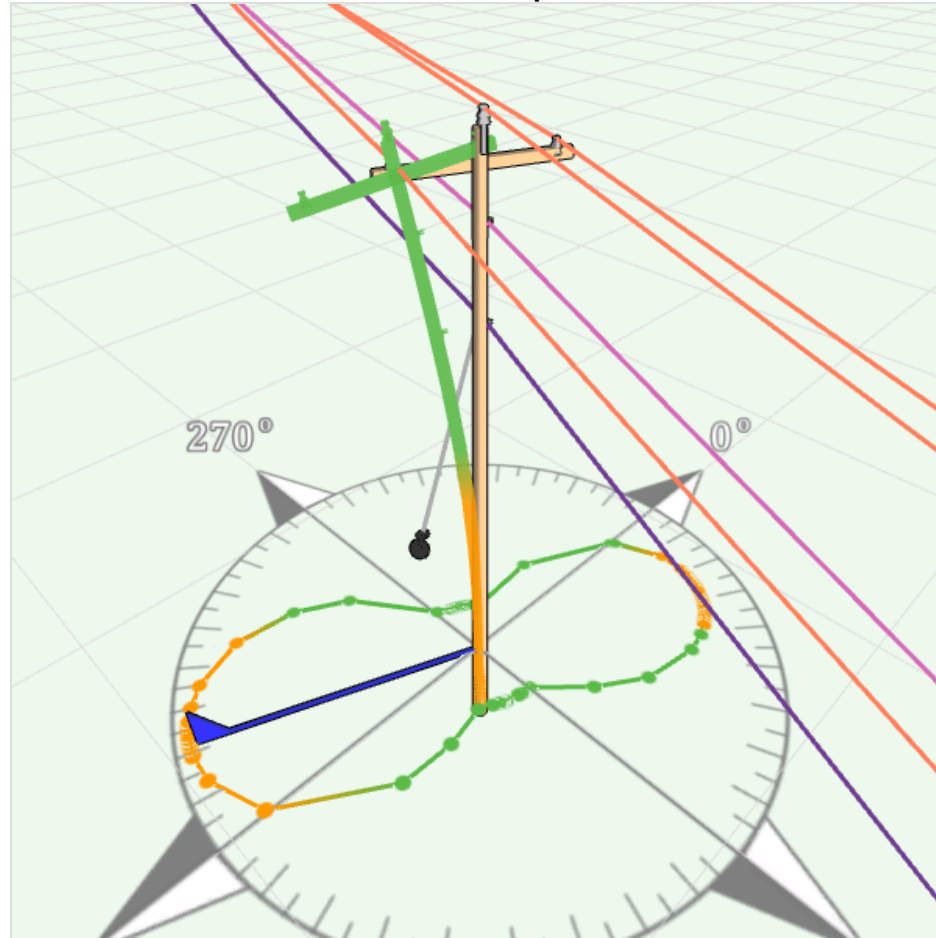

### Design Properties

Owner:	Unset Com Owner
Species:	Southern Pine
Length:	35'
Class:	5
AGL:	28' 11"
GLC:	29"
Foundation:	None
Ground Water Level:	None
Lean Angle:	0 °
Lean Direction:	0 °
Capacity Adjustment:	100%
Effective Allowable Stress:	8000 lb/in <sup>2</sup>
GPS Location:	38.94260899361544 , -91.21207152380278
Map Location:	38.942606707002724 , -91.21207250389254

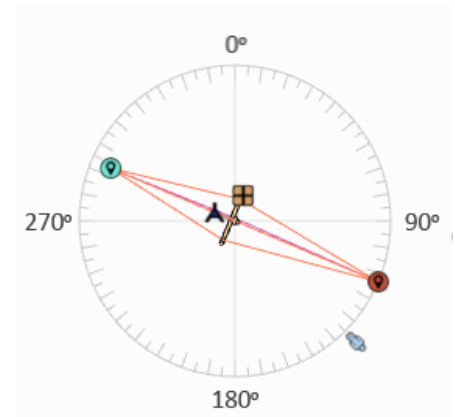
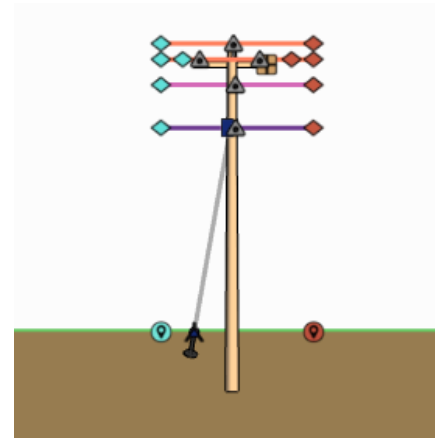

### Design Warnings

Type	Description
Analysis Near Capacity	Pole loading for Heavy Grade C - 97.89 %

### Load Case Properties

	Heavy Grade C (Governing Case)	Extreme Wind
LoadCase Type	NESC 2012 Heavy	NESC Extreme Wind 2012
Construction Grade	C	B
Construction Type	New	New
Temperature	0 °F	60 °F
Wind Pressure	4 lb/ft <sup>2</sup>	90 mph
Ice Thickness	0.5"	0"
Wind	Sweep	Sweep
Wind Direction	0 °	0 °
Wind Increment	1 °	1 °
Analysis Method	Basic (Direct Stiffness)	Basic (Direct Stiffness)
Load Percentage Allowed	100%	100%
Average Length on Main Span	No	No
Displacement Based Load Changes	None	None
Analyze Ground Line Only	No	No
Analyze with Buckling Case	No	No
Analyze with Deflection Case	No	No
Analyze with Strength Results	No	No
Custom	No	No

### Analysis Results

#### Loading

Component	Heavy Grade C (Governing Case)			Extreme Wind			Client File Maximum Rating
	Max %	Load (Applied / Allowable)	Wind Direction	Max %	Load (Applied / Allowable)	Wind Direction	
Pole - Stress	97.89 from stress	6657 lb/in <sup>2</sup> / 6800 lb/in <sup>2</sup>	202 °	18.18 from stress	1091 lb/in <sup>2</sup> / 6000 lb/in <sup>2</sup>	179 °	8000 lb/in <sup>2</sup>
Wood 8 Ft 4 x 5 (SYP) [27' 6"] (CrossArm#1) - Stress	18.31	-1152 lb/in <sup>2</sup> / 6290 lb/in <sup>2</sup>	202 °	2.92	162 lb/in <sup>2</sup> / 5550 lb/in <sup>2</sup>	112 °	7400 lb/in <sup>2</sup>
24.9 kV Pin Type Insulator (Crossarm) [0' 8"] (Insulator#1) - Force	9.51	475 lbf / 5000 lbf	203 °	0.6	30 lbf / 5000 lbf	202 °	5000 lbf
24.9 kV Pin Type Insulator (Crossarm) [7' 4"] (Insulator#2) - Force	9.53	476 lbf / 5000 lbf	23 °	0.68	34 lbf / 5000 lbf	23 °	5000 lbf
3" Spool Bolt [25' 5"] (Insulator#3) - Force	14.86	446 lbf / 3000 lbf	203 °	0.96	29 lbf / 3000 lbf	203 °	3000 lbf
24.9 kV Pin Type Insulator (Pole Top) [28' 1"] (Insulator#4) - Force	8.62	431 lbf / 5000 lbf	203 °	0.45	22 lbf / 5000 lbf	203 °	5000 lbf
Comm 3 Bolt Clamp [21' 0"] (Insulator#5) - Force	34.2	1026 lbf / 3000 lbf	203 °	7.94	238 lbf / 3000 lbf	91 °	3000 lbf
Proposed Fiber 1", Full (ProposedWire#2) - Tension	30.93	3464 lbf / 6720 lbf	N/A	N/A	N/A	N/A	11200 lbf
1/0 ACSR, Full (Wire#8) - Tension	54.72	2397 lbf / 2628 lbf	N/A	N/A	N/A	N/A	4380 lbf
1/4" EHS [21' 0"] (Guy#1) - Force	41.76	2500 lbf / 5985 lbf	43 °	19.15	1146 lbf / 5985 lbf	112 °	6650 lbf
Proposed Anchor [10' 0", 293 °] (Anchor#1) - Force	35.71	2500 lbf / 7000 lbf	43 °	16.38	1146 lbf / 7000 lbf	112 °	7000 lbf

Pole Analysis Charts for Governing Load Case: Heavy Grade C

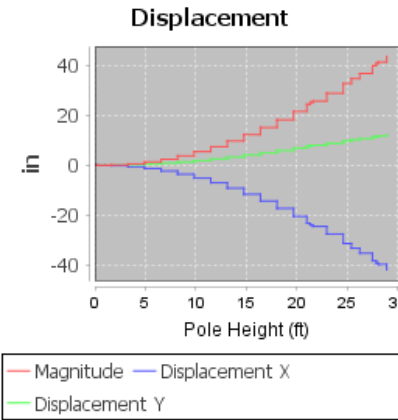
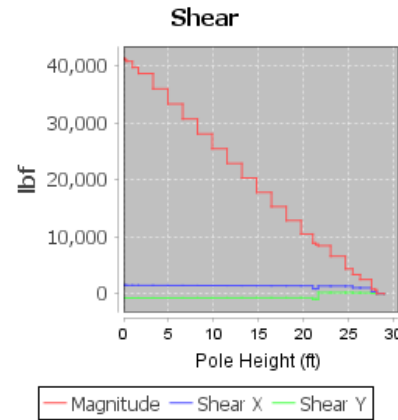
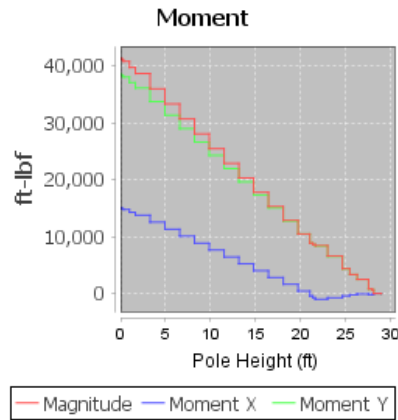
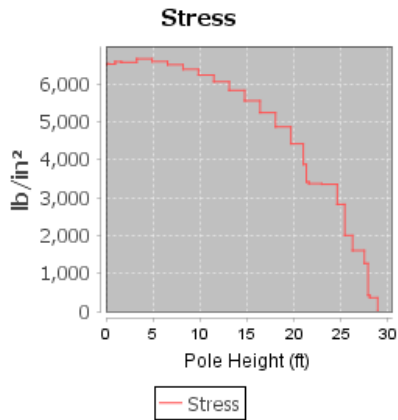

Pole Static Analysis

Heavy Grade C

Heights	Stress %	Stress (lb/in²)	Moment (ft-lbf)			Force (lbf)				Displacement (in)		
			X	Y	Magnitude	X	Y	Shear Magnitude	Axial	X	Y	Magnitude
0' 0"	95.64	6503	15017	38512	41336	1470	-759	1654	5501	0	0	0
0' 1"	95.88	6520	14967	38415	41228	1469	-759	1654	5497	0	0	0
0' 2"	95.92	6523	14868	38222	41012	1469	-758	1653	5493	0	0	0
0' 4"	95.85	6518	14768	38030	40797	1467	-758	1651	5479	0	0	0
1' 0"	96.78	6581	14271	37067	39720	1463	-756	1647	5457	0	0	0
1' 8"	96.55	6565	13775	36107	38645	1458	-754	1641	5420	0	0	0
3' 3"	97.89	6657	12538	33716	35971	1450	-751	1633	5368	-1	0	1
4' 11"	96.85	6586	11306	31337	33314	1442	-748	1625	5318	-1	0	1
6' 7"	95.62	6502	10079	28971	30675	1435	-745	1616	5270	-2	1	2
8' 2"	93.84	6381	8857	26618	28053	1427	-742	1609	5224	-4	1	4
9' 10"	91.61	6230	7640	24277	25451	1420	-739	1601	5180	-5	2	6
11' 6"	89.02	6053	6428	21947	22869	1413	-736	1593	5138	-7	3	7
13' 1"	85.67	5826	5221	19629	20312	1406	-733	1586	5097	-9	3	10
14' 9"	81.65	5552	4018	17323	17783	1399	-731	1579	5059	-12	4	12
16' 5"	77.01	5236	2820	15027	15290	1393	-728	1571	5022	-14	5	15
18' 1"	71.5	4862	1626	12743	12846	1386	-725	1565	4988	-17	6	18
19' 8"	64.93	4415	436	10469	10478	1381	-723	1558	4958	-21	7	22
21' 0"	57	3876	-416	8875	8885	851	-979	1297	4099	-23	8	25
21' 4"	50.22	3415	-735	8598	8629	850	-978	1296	4094	-24	8	25
21' 7"	49.5	3366	-1003	8366	8426	1342	194	1356	1430	-25	8	26
23' 0"	49.25	3349	-738	6532	6574	1337	196	1351	1403	-28	9	29
24' 7"	41.49	2821	-416	4339	4359	1333	198	1347	1382	-31	10	33
25' 5"	29.43	2001	-219	3340	3347	1034	155	1046	1037	-33	10	35
26' 3"	23.57	1603	-91	2482	2484	1031	156	1042	1020	-35	11	37
27' 6"	18.58	1263	-192	775	798	345	50	349	280	-38	11	40
27' 11"	6.21	423	-173	641	664	344	50	348	275	-39	12	41
28' 1"	5.27	358	0	1	1	1	-1	1	6	-40	12	42
28' 11"	0.01	1	0	0	0	0	0	0	0	-42	12	44

**Extreme Wind**

Heights	Stress %	Stress (lb/in <sup>2</sup> )	Moment (ft-lbf)			Force (lbf)				Displacement (in)		
			X	Y	Magnitude	X	Y	Shear Magnitude	Axial	X	Y	Magnitude
0' 0"	18.07	1084	1669	6669	6875	419	-67	424	1201	0	0	0
0' 1"	18.14	1089	1665	6642	6847	418	-67	423	1199	0	0	0
0' 2"	18.13	1088	1656	6587	6792	416	-67	421	1196	0	0	0
0' 4"	18.06	1084	1647	6532	6737	410	-67	415	1189	0	0	0
1' 0"	18.18	1091	1603	6263	6465	400	-67	406	1178	0	0	0
1' 8"	17.88	1073	1559	6001	6200	384	-67	390	1158	0	0	0
3' 3"	17.87	1072	1449	5371	5563	361	-68	367	1131	0	0	0
4' 11"	17.06	1023	1337	4778	4962	338	-68	345	1104	0	0	0
6' 7"	16.23	974	1226	4223	4398	316	-69	324	1079	0	0	0
8' 2"	15.34	921	1113	3705	3868	295	-69	303	1055	-1	0	1
9' 10"	14.42	865	1000	3221	3373	273	-69	282	1032	-1	0	1
11' 6"	13.48	809	887	2773	2911	253	-70	262	1010	-1	0	1
13' 1"	12.48	749	772	2359	2482	232	-70	243	988	-1	0	1
14' 9"	11.44	686	657	1977	2084	213	-70	224	968	-2	0	2
16' 5"	10.37	622	542	1629	1716	193	-71	206	949	-2	1	2
18' 1"	9.25	555	426	1312	1379	174	-71	188	931	-3	1	3
19' 8"	8.06	484	310	1025	1071	158	-71	173	915	-3	1	3
21' 0"	6.78	407	232	854	885	69	-246	256	768	-3	1	4
21' 4"	5.83	350	152	832	846	66	-246	255	765	-3	1	4
21' 7"	5.66	340	84	817	821	154	-5	154	210	-4	1	4
23' 0"	5.47	328	77	606	611	138	-6	138	196	-4	1	4
24' 7"	4.4	264	67	379	385	126	-6	126	185	-4	1	5
25' 5"	2.98	179	65	284	292	115	-6	115	149	-5	1	5
26' 3"	2.36	142	61	189	198	105	-6	105	140	-5	1	5
27' 6"	1.71	103	-1	38	38	27	-2	27	30	-5	2	6
27' 11"	0.34	21	-2	27	27	24	-2	24	27	-5	2	6
28' 1"	0.26	15	0	3	3	4	0	4	3	-6	2	6
28' 11"	0.03	2	0	0	0	0	0	0	0	-6	2	6

Measured: Proposed

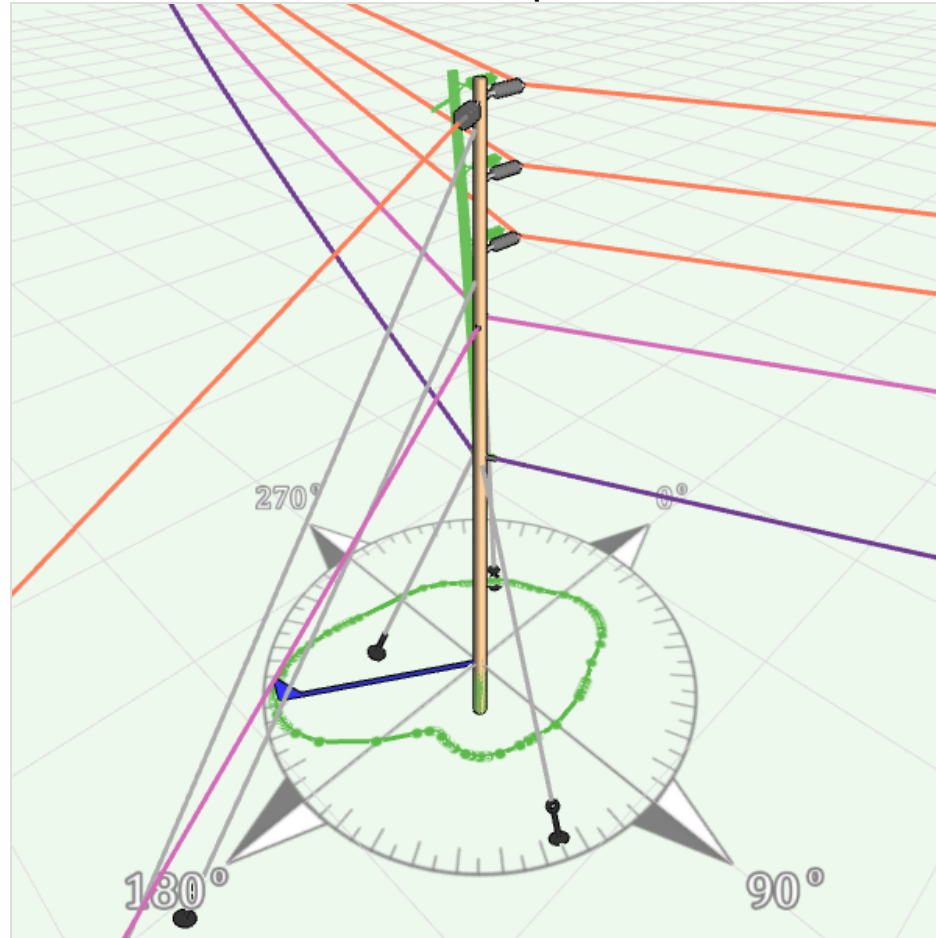



**Design Properties**

**Owner:** Unset Com Owner  
**Species:** Southern Pine  
**Length:** 50'  
**Class:** 4  
**AGL:** 43' 8"  
**GLC:** 36 1/4"  
**Foundation:** None  
**Ground Water Level:** None  
**Lean Angle:** 0 °  
**Lean Direction:** 0 °  
**Capacity Adjustment:** 100%  
**Effective Allowable Stress:** 8000 lb/in²  
**GPS Location:** 38.942231556295646 , -91.2109531920653  
**Map Location:** 38.942236224347866 , -91.2109503488453

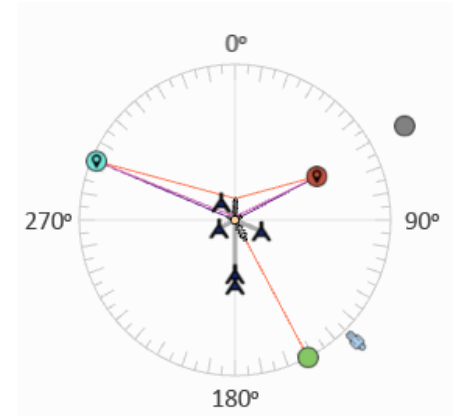
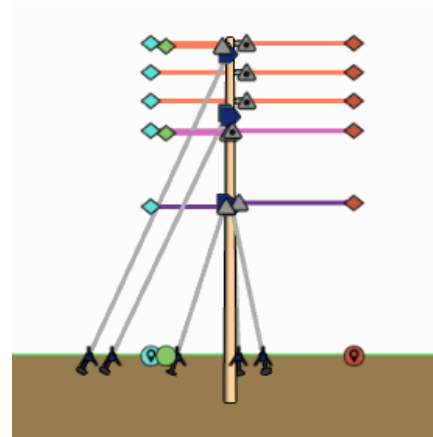

**Design Warnings**

Type	Description
Analysis Over Capacity	6 Coppenweld T type A, Full loading for Heavy Grade C - 60.65 %

**Load Case Properties**

	Heavy Grade C (Governing Case)	Extreme Wind
LoadCase Type	NESC 2012 Heavy	NESC Extreme Wind 2012
Construction Grade	C	B
Construction Type	New	New
Temperature	0 °F	60 °F
Wind Pressure	4 lb/ft²	90 mph
Ice Thickness	0.5"	0"
Wind	Sweep	Sweep
Wind Direction	0 °	0 °
Wind Increment	1 °	1 °
Analysis Method	Basic (Direct Stiffness)	Basic (Direct Stiffness)
Load Percentage Allowed	100%	100%
Average Length on Main Span	No	No
Displacement Based Load Changes	None	None
Analyze Ground Line Only	No	No
Analyze with Buckling Case	No	No
Analyze with Deflection Case	No	No
Analyze with Strength Results	No	No
Custom	No	No

### Analysis Results

#### Loading

Component	Heavy Grade C (Governing Case)			Extreme Wind			Client File Maximum Rating
	Max %	Load (Applied / Allowable)	Wind Direction	Max %	Load (Applied / Allowable)	Wind Direction	
Pole - Stress	51.69 from stress	3515 lb/in <sup>2</sup> / 6800 lb/in <sup>2</sup>	212 °	17.7 from stress	1062 lb/in <sup>2</sup> / 6000 lb/in <sup>2</sup>	74 °	8000 lb/in <sup>2</sup>
3" Spool Bolt [30' 11"] (Insulator#1) - Force	71.34	2140 lbf / 3000 lbf	12 °	12.62	379 lbf / 3000 lbf	357 °	3000 lbf
3" Spool Bolt [30' 7"] (Insulator#2) - Force	67.94	2038 lbf / 3000 lbf	242 °	10.4	312 lbf / 3000 lbf	152 °	3000 lbf
24.9 kV Running Angle Insulator [35' 0"] (Insulator#3) - Force	52.98	2649 lbf / 5000 lbf	12 °	11.85	592 lbf / 5000 lbf	321 °	5000 lbf
24.9 kV Running Angle Insulator [38' 11"] (Insulator#4) - Force	52.98	2649 lbf / 5000 lbf	12 °	11.85	592 lbf / 5000 lbf	321 °	5000 lbf
24.9 kV Running Angle Insulator [42' 11"] (Insulator#5) - Force	52.98	2649 lbf / 5000 lbf	12 °	11.85	592 lbf / 5000 lbf	321 °	5000 lbf
24.9 kV Dead End Insulator [42' 6"] (Insulator#6) - Force	40.76	2038 lbf / 5000 lbf	242 °	6.27	313 lbf / 5000 lbf	196 °	5000 lbf
Comm D/E Bolt [20' 6"] (Insulator#7) - Force	64.44	4511 lbf / 7000 lbf	23 °	20.89	1463 lbf / 7000 lbf	338 °	7000 lbf
Comm D/E Bolt [21' 0"] (Insulator#8) - Force	44.95	3147 lbf / 7000 lbf	332 °	12.7	889 lbf / 7000 lbf	17 °	7000 lbf
Proposed Fiber 1", Full (ProposedWire#1) - Tension	30.93	3464 lbf / 6720 lbf	N/A	N/A	N/A	N/A	11200 lbf
6 Copperweld T Type A, Full (Wire#3) - Tension	60.65	1568 lbf / 1551 lbf	N/A	N/A	N/A	N/A	2585 lbf
1/4" EHS [21' 0"] (DownGuy#1) - Force	20.92	1252 lbf / 5985 lbf	133 °	17.5	1048 lbf / 5985 lbf	70 °	6650 lbf
1/4" EHS [20' 6"] (DownGuy#2) - Force	98.95	5922 lbf / 5985 lbf	213 °	26.03	1558 lbf / 5985 lbf	271 °	6650 lbf
3/8" EHS [32' 10"] (Guy#1) - Force	0	0 lbf / 13860 lbf	0 °	7.38	1023 lbf / 13860 lbf	93 °	15400 lbf
3/8" EHS [33' 4"] (Guy#2) - Force	46.18	6400 lbf / 13860 lbf	2 °	17.26	2392 lbf / 13860 lbf	38 °	15400 lbf
3/8" EHS [41' 5"] (Guy#3) - Force	32.88	4557 lbf / 13860 lbf	4 °	10.33	1431 lbf / 13860 lbf	36 °	15400 lbf
Proposed Anchor [8' 0", 242 °] (Anchor#1) - Force	17.89	1252 lbf / 7000 lbf	133 °	14.96	1048 lbf / 7000 lbf	70 °	7000 lbf
Proposed Anchor [13' 0", 113 °] (Anchor#2) - Force	84.6	5922 lbf / 7000 lbf	213 °	22.25	1558 lbf / 7000 lbf	271 °	7000 lbf
F1-2 [10' 0", 322 °] (Anchor#3) - Force	0	0 lbf / 12500 lbf	0 °	8.19	1023 lbf / 12500 lbf	93 °	12500 lbf
F1-2 [25' 0", 180 °] (Anchor#4) - Force	51.2	6400 lbf / 12500 lbf	2 °	19.14	2392 lbf / 12500 lbf	38 °	12500 lbf
F1-2 [30' 0", 180 °] (Anchor#5) - Force	36.46	4557 lbf / 12500 lbf	4 °	11.45	1431 lbf / 12500 lbf	36 °	12500 lbf

#### Pole Analysis Charts for Governing Load Case: Heavy Grade C

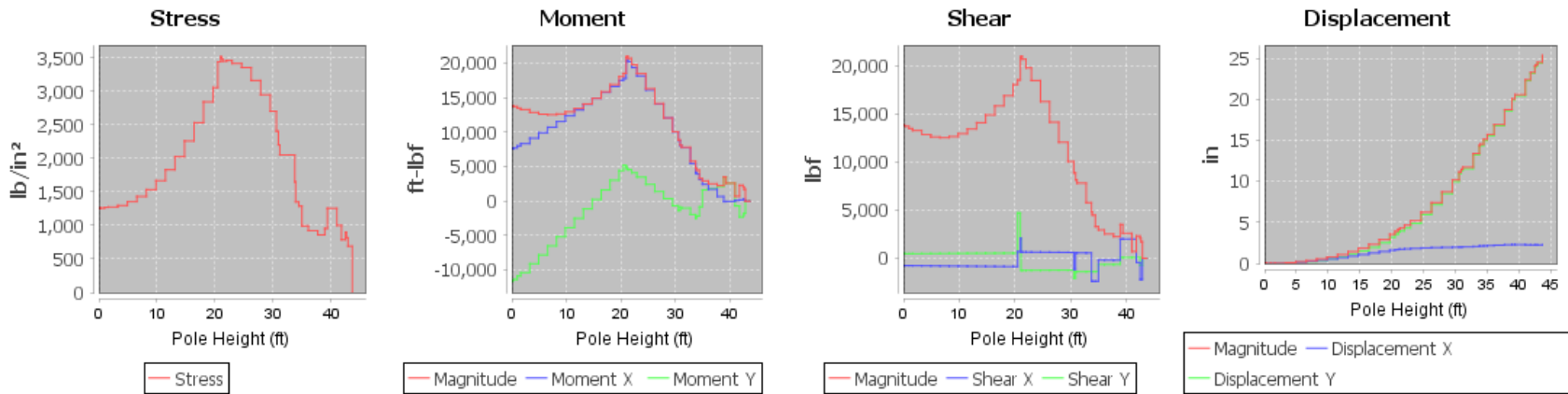

#### Pole Static Analysis

Heavy Grade C

Heights	Stress %	Stress (lb/in <sup>2</sup> )	Moment (ft-lbf)			Force (lbf)				Displacement (in)		
			X	Y	Magnitude	X	Y	Shear Magnitude	Axial	X	Y	Magnitude
0' 0"	18.46	1255	7570	-11630	13877	-764	474	899	17049	0	0	0
0' 1"	18.49	1257	7601	-11580	13852	-765	474	900	17044	0	0	0
0' 2"	18.5	1258	7664	-11479	13802	-766	475	901	17037	0	0	0
0' 4"	18.51	1258	7726	-11379	13754	-768	476	903	17016	0	0	0
1' 0"	18.66	1269	8038	-10875	13523	-772	478	908	16981	0	0	0
1' 8"	18.73	1274	8352	-10369	13314	-778	482	915	16921	0	0	0
3' 3"	19.08	1298	9143	-9092	12895	-787	488	926	16838	0	0	0
4' 11"	19.92	1354	9944	-7801	12639	-796	494	937	16758	0	0	0
6' 7"	21.05	1431	10754	-6495	12563	-805	499	947	16680	0	0	0
8' 2"	22.56	1534	11573	-5175	12677	-813	505	957	16604	0	0	1
9' 10"	24.52	1667	12400	-3841	12982	-822	510	967	16532	1	1	1
11' 6"	26.9	1829	13237	-2492	13469	-830	515	977	16461	1	1	1
13' 1"	29.78	2025	14082	-1130	14127	-839	520	987	16394	1	1	1
14' 9"	33.22	2259	14935	245	14937	-847	525	996	16328	1	1	2
16' 5"	37.23	2532	15797	1634	15881	-854	530	1006	16266	1	2	2
18' 1"	41.81	2843	16667	3036	16941	-862	535	1015	16205	1	3	3
19' 8"	44.94	3056	17544	4450	18100	-868	539	1021	16161	2	3	4
20' 6"	50.6	3441	17827	5224	18576	700	4736	4787	15699	2	4	4
21' 0"	51.69	3515	20296	4928	20885	2077	2088	2945	15391	2	4	4
21' 1"	51.31	3489	20517	4710	21051	656	-1253	1414	9699	2	4	4
21' 4"	50.74	3450	20241	4565	20749	654	-1252	1412	9684	2	4	4
22' 0"	50.88	3460	19401	4127	19835	649	-1249	1407	9654	2	4	5
23' 0"	50.22	3415	18191	3498	18524	643	-1245	1401	9612	2	5	5
24' 7"	49.33	3355	16149	2442	16332	636	-1240	1394	9560	2	6	6
26' 3"	46.5	3162	14114	1399	14183	629	-1236	1387	9511	2	7	7
27' 11"	43.35	2948	12086	367	12092	622	-1232	1380	9463	2	8	9
29' 6"	39.74	2702	10066	-654	10087	617	-1228	1374	9426	2	10	10
30' 7"	35.38	2406	8800	-1362	8905	-1156	-2058	2360	9215	2	11	11
30' 11"	32.39	2202	8116	-865	8162	566	-1398	1508	8874	2	11	11
31' 2"	30.16	2051	7765	-1007	7830	563	-1396	1505	8850	2	12	12
32' 10"	30.18	2052	5476	-1930	5806	558	-1392	1500	8817	2	13	13
33' 9"	24.28	1651	4143	-2466	4821	-2385	-1389	2760	4900	2	14	14
33' 11"	19.88	1352	3961	-2148	4506	-2389	-1386	2763	4883	2	14	15
34' 5"	18.93	1287	3196	-831	3302	-2392	-1385	2764	4870	2	15	15
35' 0"	14.61	993	2453	1642	2952	-182	-652	677	4473	2	16	16
36' 1"	13.56	922	1743	1840	2534	-187	-649	675	4442	2	17	17
37' 9"	12.62	858	678	2147	2251	-192	-646	674	4411	2	19	19
38' 11"	14.05	955	-68	3522	3523	2018	87	2019	4017	2	20	20
39' 4"	18.47	1256	-28	2607	2607	2014	90	2016	3995	2	20	21
41' 0"	14.72	1001	119	-696	707	2010	92	2012	3971	2	22	22
41' 10"	11.57	787	194	-2312	2320	-437	97	447	597	2	23	23
42' 6"	13.2	897	286	-2060	2080	-2209	-733	2328	397	2	24	24
42' 8"	12.02	817	175	-1726	1735	-2210	-733	2328	393	2	24	24
42' 11"	10.16	691	1	1	1	1	-1	1	7	2	24	25
43' 8"	0.01	1	0	0	0	0	0	0	0	2	25	25

**Extreme Wind**

Heights	Stress %	Stress (lb/in <sup>2</sup> )	Moment (ft-lbf)			Force (lbf)				Displacement (in)		
			X	Y	Magnitude	X	Y	Shear Magnitude	Axial	X	Y	Magnitude
0' 0"	11.4	684	517	-7961	7978	-614	-102	622	6048	0	0	0
0' 1"	11.45	687	511	-7921	7937	-613	-104	622	6045	0	0	0
0' 2"	11.42	685	497	-7841	7856	-612	-106	622	6041	0	0	0
0' 4"	11.36	681	483	-7760	7775	-610	-113	621	6030	0	0	0
1' 0"	11.38	683	409	-7360	7371	-607	-126	620	6012	0	0	0
1' 8"	11.04	663	326	-6962	6969	-601	-147	618	5980	0	0	0
3' 3"	10.83	650	86	-5976	5977	-592	-176	618	5936	0	0	0
4' 11"	9.88	593	-203	-5004	5008	-584	-205	619	5894	0	0	0
6' 7"	8.86	531	-540	-4046	4082	-576	-234	621	5853	0	0	0
8' 2"	7.77	466	-924	-3102	3237	-568	-262	625	5813	0	0	0
9' 10"	6.69	402	-1354	-2171	2558	-560	-290	630	5775	0	0	0
11' 6"	5.8	348	-1829	-1253	2217	-552	-317	636	5738	0	0	0
13' 1"	7.21	433	-2349	-347	2375	-544	-344	644	5703	1	0	1
14' 9"	9.39	563	-2913	546	2964	-537	-370	652	5668	1	0	1
16' 5"	12.1	726	-3520	1426	3798	-529	-396	661	5635	1	0	1
18' 1"	15.26	916	-4169	2294	4759	-522	-421	671	5603	1	0	1
19' 8"	17.24	1035	-4860	3151	5792	-517	-440	678	5580	1	0	1
20' 6"	16.72	1003	-5244	3583	6351	58	893	895	5496	1	0	1
21' 0"	17.7	1062	-4780	3563	5962	477	106	488	5439	1	0	1
21' 1"	16.86	1012	-4771	3512	5924	462	58	465	5366	1	0	1
21' 4"	16.85	1011	-4758	3410	5854	463	51	466	5358	1	0	1
22' 0"	16.93	1016	-4729	3098	5653	292	367	469	4366	1	0	1
23' 0"	16.64	998	-4373	2815	5201	297	348	458	4344	1	-1	1
24' 7"	16.14	968	-3801	2328	4458	304	325	445	4317	1	-1	1
26' 3"	14.86	891	-3268	1830	3746	310	302	433	4291	1	-1	2
27' 11"	13.49	809	-2772	1321	3071	317	280	423	4266	1	-1	2
29' 6"	12	720	-2313	802	2448	322	262	415	4246	1	-2	2
30' 7"	10.35	621	-2033	457	2084	51	106	118	4217	1	-2	2
30' 11"	9.25	555	-1998	450	2048	428	117	444	4182	1	-2	2
31' 2"	9.21	552	-1968	342	1998	432	105	444	4169	1	-2	2
32' 10"	9.37	562	-1796	-366	1833	436	88	445	4151	1	-2	2
33' 9"	9.16	550	-1717	-787	1889	-942	68	944	2304	1	-2	3
33' 11"	8.96	538	-1720	-666	1845	-715	228	750	1381	1	-2	3
34' 5"	8.57	514	-1595	-272	1618	-713	221	746	1374	1	-3	3
35' 0"	7.75	465	-1471	248	1491	-120	227	257	1322	1	-3	3
36' 1"	7.42	445	-1223	378	1280	-115	211	240	1306	1	-3	3
37' 9"	6.83	410	-877	567	1044	-110	194	223	1289	1	-3	3
38' 11"	6.03	362	-644	824	1046	483	201	523	1238	1	-4	4
39' 4"	6.23	374	-553	605	820	486	189	521	1227	1	-4	4
41' 0"	5.23	314	-243	-192	310	490	175	520	1214	1	-4	4
41' 10"	2.43	146	-109	-589	599	-323	151	356	76	1	-4	5
42' 6"	3.83	230	-3	-373	373	-594	-5	594	52	1	-5	5
42' 8"	2.43	146	-3	-283	283	-593	-7	593	50	1	-5	5
42' 11"	1.87	112	-3	-1	3	-1	4	4	4	1	-5	5
43' 8"	0.02	1	0	0	0	0	0	0	0	1	-5	5

Measured: Proposed

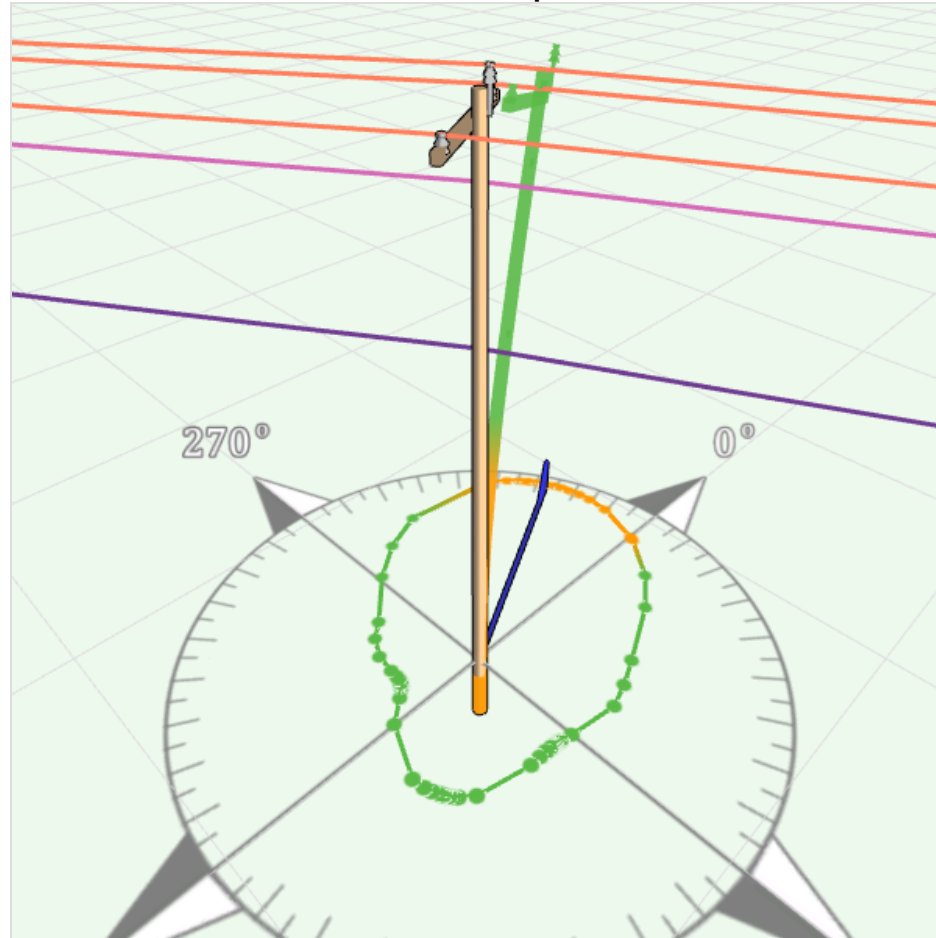

### Design Properties

**Owner:** Unset Com Owner  
**Species:** Southern Pine  
**Length:** 35'  
**Class:** 5  
**AGL:** 30' 3"  
**GLC:** 29 1/2"  
**Foundation:** None  
**Ground Water Level:** None  
**Lean Angle:** 0 °  
**Lean Direction:** 0 °  
**Capacity Adjustment:** 100%  
**Effective Allowable Stress:** 8000 lb/in²  
**GPS Location:** 38.942506980166684 , -91.21029102396801  
**Map Location:** 38.942510251374266 , -91.21028772525308

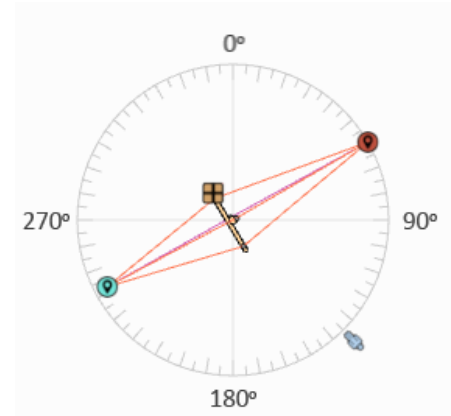
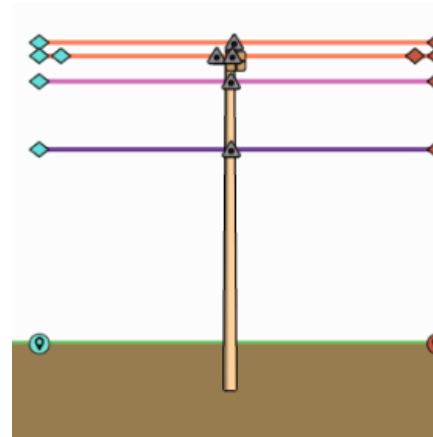

### Design Warnings

Type	Description
Analysis Near Capacity	Pole loading for Heavy Grade C - 99.32 %

### Load Case Properties

	Heavy Grade C (Governing Case)	Extreme Wind
LoadCase Type	NESC 2012 Heavy	NESC Extreme Wind 2012
Construction Grade	C	B
Construction Type	New	New
Temperature	0 °F	60 °F
Wind Pressure	4 lb/ft²	90 mph
Ice Thickness	0.5"	0"
Wind	Sweep	Sweep
Wind Direction	0 °	0 °
Wind Increment	1 °	1 °
Analysis Method	Basic (Direct Stiffness)	Basic (Direct Stiffness)
Load Percentage Allowed	100%	100%
Average Length on Main Span	No	No
Displacement Based Load Changes	None	None
Analyze Ground Line Only	No	No
Analyze with Buckling Case	No	No
Analyze with Deflection Case	No	No
Analyze with Strength Results	No	No
Custom	No	No

### Analysis Results

#### Loading

Component	Heavy Grade C (Governing Case)			Extreme Wind			Client File Maximum Rating
	Max %	Load (Applied / Allowable)	Wind Direction	Max %	Load (Applied / Allowable)	Wind Direction	
Pole - Stress	99.32 from stress	6754 lb/in² / 6800 lb/in²	332 °	34.41 from stress	2065 lb/in² / 6000 lb/in²	39 °	8000 lb/in²
Wood 8 Ft 4 x 5 (SYP) [29' 1"] (CrossArm#1) - Stress	15.04	-946 lb/in² / 6290 lb/in²	327 °	3.07	-170 lb/in² / 5550 lb/in²	55 °	7400 lb/in²
24.9 kV Pin Type Insulator (Crossarm) [0' 8"] (Insulator#1) - Force	8.3	415 lbf / 5000 lbf	330 °	0.84	42 lbf / 5000 lbf	331 °	5000 lbf
24.9 kV Pin Type Insulator (Crossarm) [7' 4"] (Insulator#2) - Force	8.3	415 lbf / 5000 lbf	330 °	0.84	42 lbf / 5000 lbf	331 °	5000 lbf
3" Spool Bolt [27' 0"] (Insulator#3) - Force	12.32	370 lbf / 3000 lbf	330 °	1	30 lbf / 3000 lbf	331 °	3000 lbf
24.9 kV Pin Type Insulator (Pole Top) [29' 5"] (Insulator#4) - Force	8.31	416 lbf / 5000 lbf	330 °	0.87	43 lbf / 5000 lbf	331 °	5000 lbf
Comm 3 Bolt Clamp [20' 0"] (Insulator#5) - Force	24.58	737 lbf / 3000 lbf	329 °	7.15	214 lbf / 3000 lbf	35 °	3000 lbf
Proposed Fiber 1", Full (ProposedWire#2) - Tension	23.98	2686 lbf / 6720 lbf	N/A	N/A	N/A	N/A	11200 lbf
1/0 ACSR, Full (Wire#8) - Tension	46.77	2049 lbf / 2628 lbf	N/A	N/A	N/A	N/A	4380 lbf

Pole Analysis Charts for Governing Load Case: Heavy Grade C

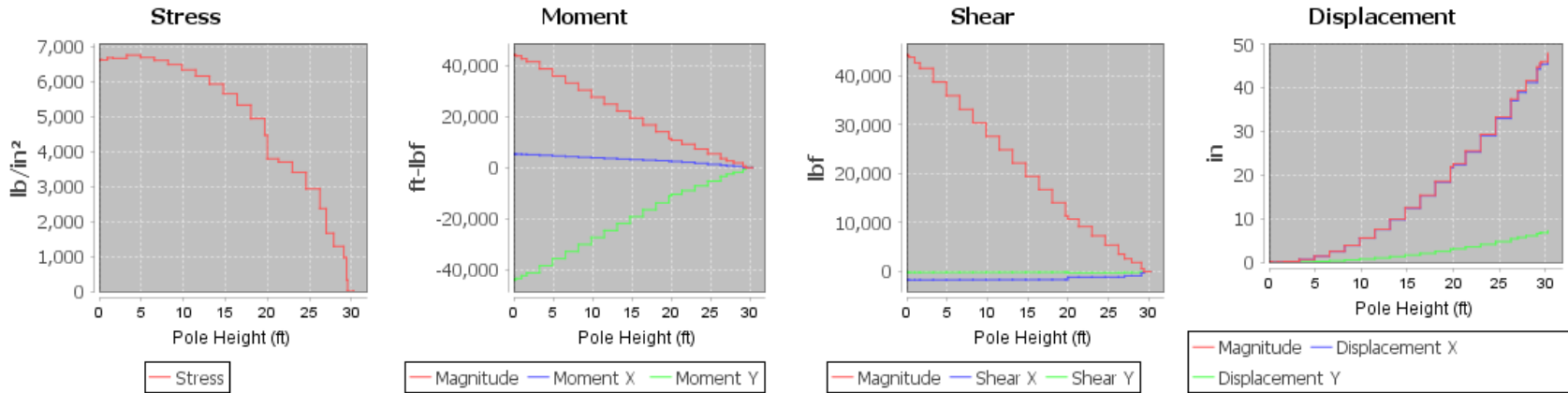

Pole Static Analysis

Heavy Grade C

Heights	Stress %	Stress (lb/in <sup>2</sup> )	Moment (ft-lbf)			Force (lbf)					Displacement (in)		
			X	Y	Magnitude	X	Y	Shear Magnitude	Axial	X	Y	Magnitude	
0' 0"	97.05	6599	5376	-43965	44292	-1713	-167	1721	2521	0	0	0	
0' 1"	97.29	6616	5365	-43852	44179	-1713	-167	1721	2518	0	0	0	
0' 2"	97.33	6618	5343	-43628	43954	-1712	-167	1720	2513	0	0	0	
0' 4"	97.26	6614	5321	-43403	43728	-1710	-166	1718	2499	0	0	0	
1' 0"	98.2	6677	5213	-42281	42601	-1707	-164	1715	2476	0	0	0	
1' 8"	97.97	6662	5105	-41161	41476	-1702	-161	1709	2438	0	0	0	
3' 3"	99.32	6754	4841	-38369	38674	-1694	-157	1701	2384	1	0	1	
4' 11"	98.3	6685	4584	-35590	35884	-1687	-153	1693	2332	1	0	1	
6' 7"	97.09	6602	4333	-32824	33108	-1679	-149	1686	2282	2	0	2	
8' 2"	95.33	6482	4088	-30069	30346	-1672	-145	1678	2235	4	0	4	
9' 10"	93.11	6331	3850	-27326	27596	-1665	-142	1671	2189	5	1	6	
11' 6"	90.51	6155	3617	-24595	24859	-1658	-138	1664	2146	7	1	8	
13' 1"	87.14	5926	3391	-21875	22136	-1652	-134	1657	2104	10	1	10	
14' 9"	83.07	5648	3171	-19165	19426	-1645	-131	1650	2064	12	2	12	
16' 5"	78.31	5325	2956	-16467	16730	-1639	-127	1644	2026	15	2	15	
18' 1"	72.6	4937	2747	-13779	14050	-1632	-124	1637	1990	18	2	18	
19' 8"	65.64	4464	2543	-11101	11389	-1629	-122	1633	1969	22	3	22	
20' 0"	55.7	3788	2435	-10445	10725	-1132	-246	1158	1419	22	3	23	
21' 4"	54.34	3695	2109	-8945	9190	-1127	-243	1153	1390	25	3	25	
23' 0"	50.02	3402	1709	-7097	7300	-1121	-240	1146	1359	29	4	29	
24' 7"	43.07	2928	1315	-5258	5420	-1115	-237	1140	1329	33	5	33	
26' 3"	34.78	2365	926	-3429	3552	-1111	-235	1136	1309	37	5	37	
27' 0"	24.42	1661	718	-2528	2628	-857	-183	876	1029	39	6	39	
27' 11"	18.89	1284	555	-1768	1854	-853	-182	872	1013	41	6	42	
29' 1"	14.2	965	26	-593	593	-286	-61	292	316	44	7	45	
29' 5"	4.72	321	1	-1	1	-2	-1	3	12	45	7	46	
29' 6"	0.02	1	0	-1	1	-1	-1	1	5	45	7	46	
30' 3"	0.01	1	0	0	0	0	0	0	0	47	7	48	

**Extreme Wind**

Heights	Stress %	Stress (lb/in <sup>2</sup> )	Moment (ft-lbf)			Force (lbf)				Displacement (in)		
			X	Y	Magnitude	X	Y	Shear Magnitude	Axial	X	Y	Magnitude
0' 0"	34.13	2048	-7365	-11636	13771	-585	423	722	642	0	0	0
0' 1"	34.25	2055	-7337	-11597	13723	-584	422	721	640	0	0	0
0' 2"	34.23	2054	-7281	-11521	13629	-583	421	719	638	0	0	0
0' 4"	34.14	2049	-7226	-11444	13535	-578	417	713	631	0	0	0
1' 0"	34.41	2065	-6952	-11065	13068	-571	411	703	619	0	0	0
1' 8"	34.02	2041	-6683	-10691	12607	-558	401	687	598	0	0	0
3' 3"	34.18	2051	-6025	-9776	11484	-539	386	663	570	0	0	0
4' 11"	33.04	1983	-5392	-8891	10398	-522	371	640	543	0	0	0
6' 7"	31.85	1911	-4783	-8036	9351	-504	357	618	517	1	0	1
8' 2"	30.48	1829	-4197	-7209	8341	-487	343	596	491	1	-1	1
9' 10"	28.97	1738	-3633	-6410	7368	-470	330	574	467	1	-1	2
11' 6"	27.35	1641	-3092	-5639	6431	-454	317	553	444	2	-1	2
13' 1"	25.51	1531	-2573	-4895	5530	-438	304	533	423	2	-1	3
14' 9"	23.48	1409	-2075	-4177	4664	-422	291	512	402	3	-2	4
16' 5"	21.27	1276	-1598	-3485	3834	-407	278	493	382	4	-2	4
18' 1"	18.82	1129	-1141	-2817	3040	-392	266	474	363	5	-3	5
19' 8"	16.07	964	-704	-2175	2286	-383	259	462	351	5	-3	6
20' 0"	12.65	759	-634	-2031	2128	-252	101	271	257	5	-3	6
21' 4"	12.21	733	-501	-1697	1769	-239	90	256	241	6	-4	7
23' 0"	10.9	654	-352	-1304	1351	-225	79	239	225	7	-4	8
24' 7"	9.02	541	-223	-935	961	-212	68	223	209	8	-5	9
26' 3"	6.97	418	-111	-587	597	-202	60	211	199	9	-5	10
27' 0"	4.64	279	-69	-428	434	-181	62	192	166	9	-5	11
27' 11"	3.53	212	-14	-267	268	-173	55	182	158	10	-6	11
29' 1"	2.33	140	2	-59	59	-35	0	35	41	10	-6	12
29' 5"	0.54	32	-2	-3	3	-6	5	8	6	11	-6	12
29' 6"	0.03	2	-2	-2	3	-3	2	3	3	11	-6	12
30' 3"	0.02	1	0	0	0	0	0	0	0	11	-6	13



Measured: Proposed

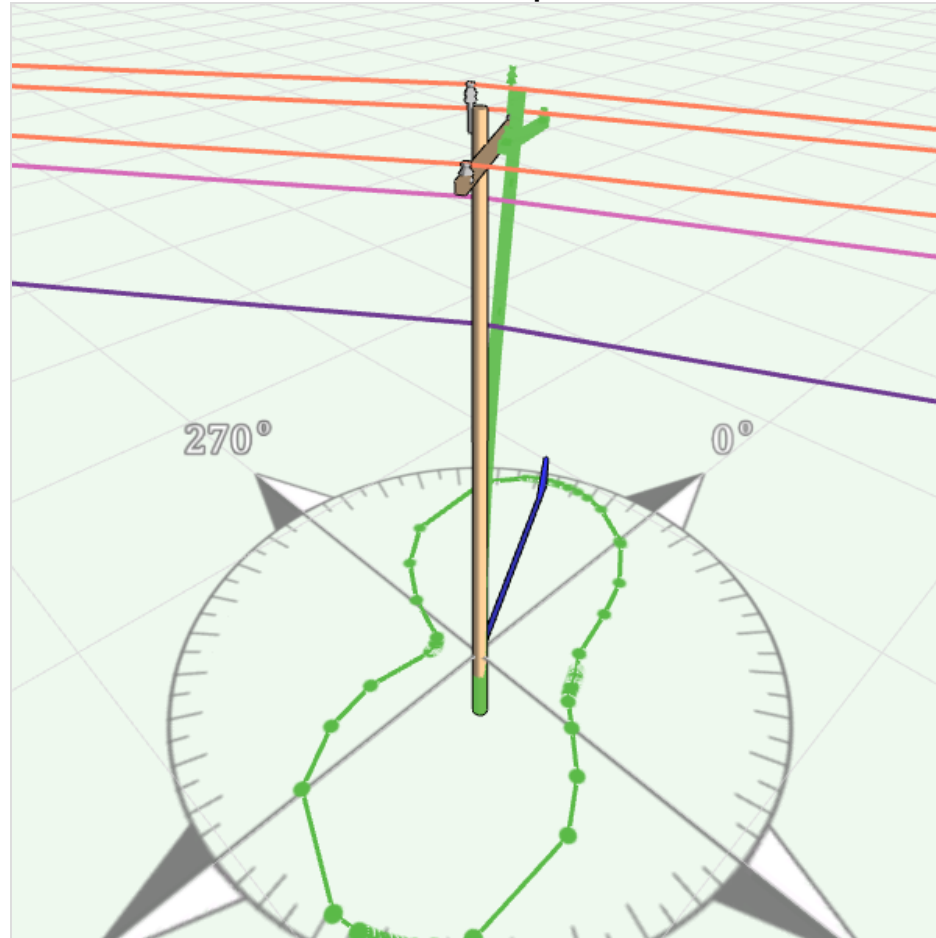

**Design Properties**

**Owner:** Unset Com Owner  
**Species:** Southern Pine  
**Length:** 35'  
**Class:** 5  
**AGL:** 29' 7"  
**GLC:** 29 1/4"  
**Foundation:** None  
**Ground Water Level:** None  
**Lean Angle:** 0 °  
**Lean Direction:** 0 °  
**Capacity Adjustment:** 100%  
**Effective Allowable Stress:** 8000 lb/in<sup>2</sup>  
**GPS Location:** 38.94283000218178 , -91.20958372950554  
**Map Location:** 38.942829501049566 , -91.2095767722836

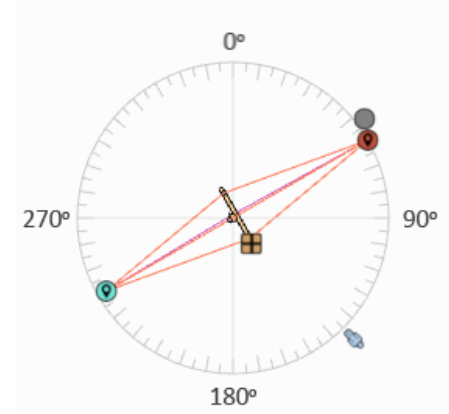
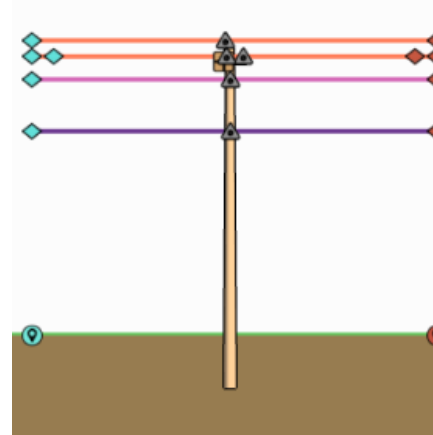

**Load Case Properties**

	Heavy Grade C (Governing Case)	Extreme Wind
LoadCase Type	NESC 2012 Heavy	NESC Extreme Wind 2012
Construction Grade	C	B
Construction Type	New	New
Temperature	0 °F	60 °F
Wind Pressure	4 lb/ft <sup>2</sup>	90 mph
Ice Thickness	0.5"	0"
Wind	Sweep	Sweep
Wind Direction	0 °	0 °
Wind Increment	1 °	1 °
Analysis Method	Basic (Direct Stiffness)	Basic (Direct Stiffness)
Load Percentage Allowed	100%	100%
Average Length on Main Span	No	No
Displacement Based Load Changes	None	None
Analyze Ground Line Only	No	No
Analyze with Buckling Case	No	No
Analyze with Deflection Case	No	No
Analyze with Strength Results	No	No
Custom	No	No

**Analysis Results**

**Loading**

Component	Heavy Grade C (Governing Case)			Extreme Wind			Client File Maximum Rating
	Max %	Load (Applied / Allowable)	Wind Direction	Max %	Load (Applied / Allowable)	Wind Direction	
Pole - Stress	72.68 from stress	4943 lb/in <sup>2</sup> / 6800 lb/in <sup>2</sup>	332 °	22.51 from stress	1351 lb/in <sup>2</sup> / 6000 lb/in <sup>2</sup>	61 °	8000 lb/in <sup>2</sup>
Wood 8 Ft 4 x 5 (SYP) [28' 2"] (CrossArm#1) - Stress	14.52	-913 lb/in <sup>2</sup> / 6290 lb/in <sup>2</sup>	331 °	2.9	-161 lb/in <sup>2</sup> / 5550 lb/in <sup>2</sup>	58 °	7400 lb/in <sup>2</sup>
24.9 kV Pin Type Insulator (Crossarm) [0' 8"] (Insulator#1) - Force	7.43	372 lbf / 5000 lbf	330 °	0.66	33 lbf / 5000 lbf	330 °	5000 lbf
24.9 kV Pin Type Insulator (Crossarm) [7' 4"] (Insulator#2) - Force	7.46	373 lbf / 5000 lbf	150 °	0.66	33 lbf / 5000 lbf	150 °	5000 lbf
3" Spool Bolt [26' 4"] (Insulator#3) - Force	12.05	361 lbf / 3000 lbf	150 °	0.97	29 lbf / 3000 lbf	150 °	3000 lbf
24.9 kV Pin Type Insulator (Pole Top) [28' 9"] (Insulator#4) - Force	7.99	399 lbf / 5000 lbf	330 °	0.76	38 lbf / 5000 lbf	330 °	5000 lbf
Comm 3 Bolt Clamp [21' 0"] (Insulator#5) - Force	23.7	711 lbf / 3000 lbf	150 °	3.57	107 lbf / 3000 lbf	177 °	3000 lbf
Proposed Fiber 1", Full (ProposedWire#2) - Tension	24.52	2746 lbf / 6720 lbf	N/A	N/A	N/A	N/A	11200 lbf
1/0 ACSR, Full (Wire#8) - Tension	47.9	2098 lbf / 2628 lbf	N/A	N/A	N/A	N/A	4380 lbf

Pole Analysis Charts for Governing Load Case: Heavy Grade C

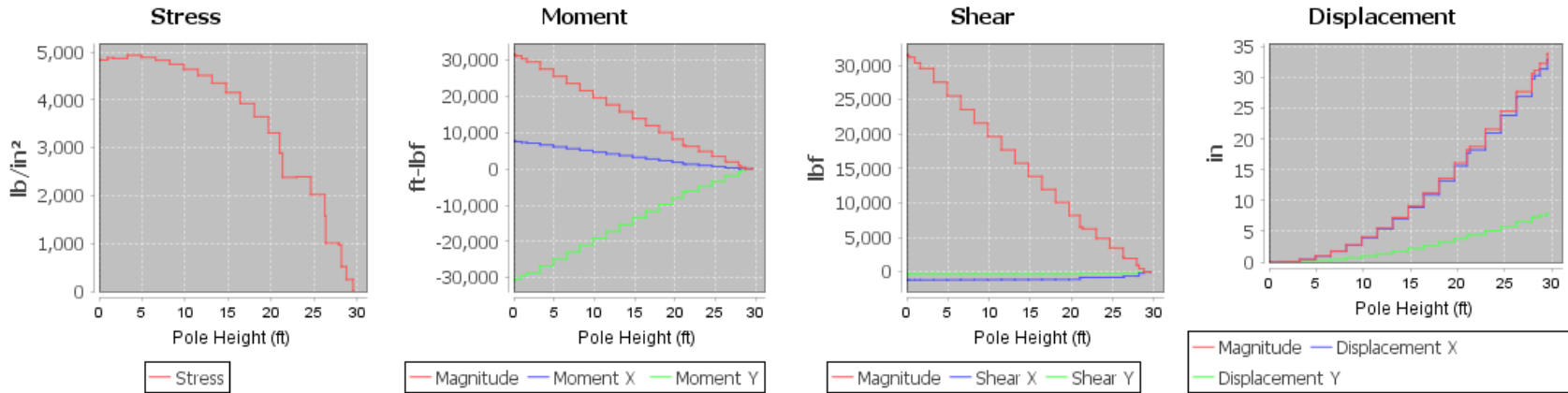

Pole Static Analysis

Heavy Grade C

Heights	Stress %	Stress (lb/in <sup>2</sup> )	Moment (ft-lbf)			Force (lbf)				Displacement (in)		
			X	Y	Magnitude	X	Y	Shear Magnitude	Axial	X	Y	Magnitude
0' 0"	71	4828	7631	-30627	31563	-1194	-317	1236	2700	0	0	0
0' 1"	71.18	4840	7610	-30549	31482	-1194	-317	1235	2697	0	0	0
0' 2"	71.21	4842	7569	-30392	31320	-1193	-317	1234	2692	0	0	0
0' 4"	71.16	4839	7527	-30235	31158	-1191	-316	1232	2679	0	0	0
1' 0"	71.84	4885	7320	-29454	30350	-1188	-314	1229	2656	0	0	0
1' 8"	71.68	4874	7114	-28674	29544	-1183	-311	1223	2618	0	0	0
3' 3"	72.68	4943	6604	-26734	27538	-1175	-307	1215	2565	0	0	0
4' 11"	71.95	4893	6100	-24807	25546	-1168	-303	1206	2514	1	0	1
6' 7"	71.1	4834	5603	-22891	23567	-1160	-299	1198	2465	2	0	2
8' 2"	69.84	4749	5112	-20987	21601	-1153	-295	1191	2419	3	1	3
9' 10"	68.27	4642	4627	-19095	19648	-1146	-292	1183	2374	4	1	4
11' 6"	66.43	4517	4148	-17215	17708	-1140	-288	1175	2331	5	1	6
13' 1"	64.04	4355	3676	-15345	15779	-1133	-285	1168	2290	7	2	7
14' 9"	61.15	4158	3209	-13487	13863	-1126	-281	1161	2251	9	2	9
16' 5"	57.77	3928	2747	-11639	11959	-1120	-278	1154	2214	11	3	11
18' 1"	53.71	3652	2292	-9801	10066	-1114	-275	1147	2178	13	3	14
19' 8"	48.74	3314	1841	-7974	8184	-1109	-272	1141	2148	16	4	16
21' 0"	42.51	2891	1376	-6362	6510	-830	-202	854	1487	18	4	18
21' 4"	35.07	2385	1311	-6092	6232	-826	-200	850	1468	18	4	19
23' 0"	35.23	2395	982	-4737	4837	-821	-197	844	1437	21	5	22
24' 7"	29.71	2020	659	-3390	3454	-815	-194	838	1409	24	6	25
26' 3"	23.16	1575	340	-2053	2081	-812	-193	835	1394	27	7	28
26' 4"	14.84	1009	277	-1917	1937	-624	-150	642	1079	27	7	28
27' 11"	14.31	973	44	-948	949	-621	-149	638	1065	30	7	31
28' 2"	7.61	517	207	-403	453	-215	-51	221	354	30	7	31
28' 9"	3.64	247	1	-1	1	-1	-1	2	7	31	8	32
29' 6"	0.01	1	0	0	0	0	0	0	0	33	8	34
29' 7"	0	0	0	0	0	0	0	0	0	33	8	34

**Extreme Wind**

Heights	Stress %	Stress (lb/in <sup>2</sup> )	Moment (ft-lbf)			Force (lbf)				Displacement (in)		
			X	Y	Magnitude	X	Y	Shear Magnitude	Axial	X	Y	Magnitude
0' 0"	22.34	1341	-7662	-4296	8784	-239	433	495	660	0	0	0
0' 1"	22.43	1346	-7633	-4280	8751	-238	432	493	658	0	0	0
0' 2"	22.41	1345	-7577	-4249	8687	-238	430	491	656	0	0	0
0' 4"	22.34	1341	-7520	-4218	8622	-235	425	486	649	0	0	0
1' 0"	22.51	1351	-7241	-4064	8303	-230	417	476	637	0	0	0
1' 8"	22.2	1332	-6968	-3913	7991	-222	402	460	617	0	0	0
3' 3"	22.26	1335	-6308	-3548	7237	-211	382	436	589	0	0	0
4' 11"	21.41	1285	-5681	-3203	6522	-200	362	413	562	0	0	0
6' 7"	20.55	1233	-5087	-2875	5843	-189	342	391	536	0	0	0
8' 2"	19.6	1176	-4525	-2565	5202	-178	323	369	512	0	-1	1
9' 10"	18.61	1117	-3995	-2272	4596	-168	305	348	488	1	-1	1
11' 6"	17.59	1055	-3495	-1997	4025	-158	286	327	465	1	-1	1
13' 1"	16.48	989	-3025	-1738	3489	-148	268	307	444	1	-2	2
14' 9"	15.3	918	-2585	-1495	2986	-138	251	287	423	1	-2	2
16' 5"	14.08	845	-2173	-1269	2516	-129	234	267	404	1	-2	3
18' 1"	12.78	767	-1789	-1057	2078	-120	217	248	385	2	-3	3
19' 8"	11.38	683	-1433	-861	1672	-111	203	231	369	2	-4	4
21' 0"	9.81	589	-1184	-689	1370	-108	191	220	253	2	-4	5
21' 4"	8.34	501	-1122	-654	1299	-103	182	209	244	2	-4	5
23' 0"	8.29	498	-824	-485	956	-94	166	191	228	3	-5	5
24' 7"	6.63	398	-551	-331	642	-86	151	174	212	3	-5	6
26' 3"	4.86	291	-302	-189	357	-82	144	165	205	3	-6	7
26' 4"	2.86	172	-294	-176	343	-78	135	156	169	3	-6	7
27' 11"	2.86	172	-85	-55	101	-73	127	147	161	4	-6	7
28' 2"	0.94	57	-6	-8	10	-12	16	20	47	4	-7	8
28' 9"	0.12	7	-3	-2	3	-2	4	4	4	4	-7	8
29' 6"	0.03	2	0	0	0	0	0	0	0	4	-7	8
29' 7"	0	0	0	0	0	0	0	0	0	4	-7	8

Measured: Proposed

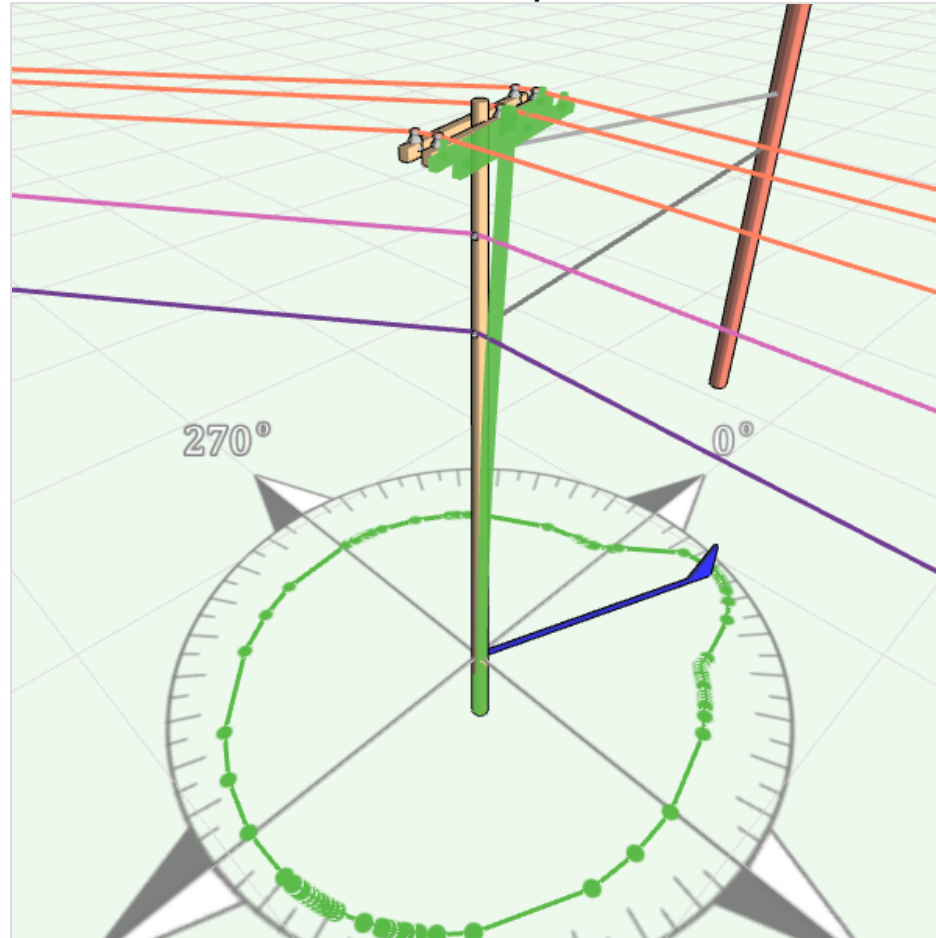

**Design Properties**

**Owner:** Unset Com Owner  
**Species:** Southern Pine  
**Length:** 35'  
**Class:** 4  
**AGL:** 29' 10"  
**GLC:** 32 1/4"  
**Foundation:** None  
**Ground Water Level:** None  
**Lean Angle:** 0 °  
**Lean Direction:** 0 °  
**Capacity Adjustment:** 100%  
**Effective Allowable Stress:** 8000 lb/in²  
**GPS Location:** 38.94314294034519 , -91.20881006716246  
**Map Location:** 38.94316930313128 , -91.20882004618281

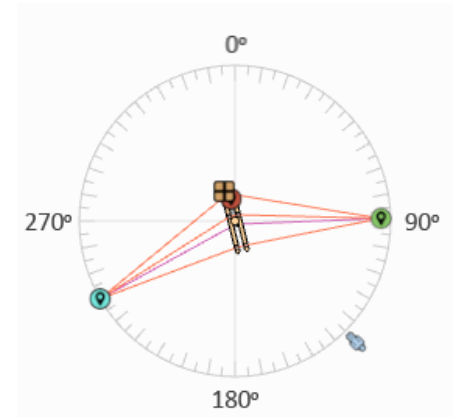
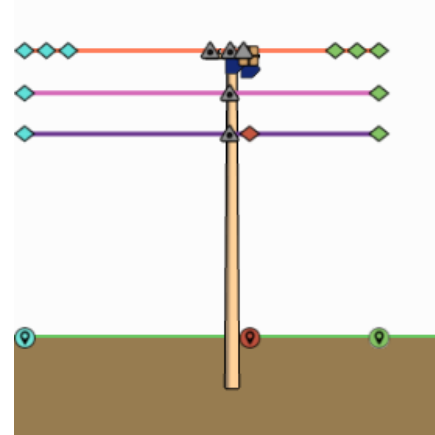

**Load Case Properties**

	Heavy Grade C (Governing Case)	Extreme Wind
LoadCase Type	NESC 2012 Heavy	NESC Extreme Wind 2012
Construction Grade	C	B
Construction Type	New	New
Temperature	0 °F	60 °F
Wind Pressure	4 lb/ft²	90 mph
Ice Thickness	0.5"	0"
Wind	Sweep	Sweep
Wind Direction	0 °	0 °
Wind Increment	1 °	1 °
Analysis Method	Basic (Direct Stiffness)	Basic (Direct Stiffness)
Load Percentage Allowed	100%	100%
Average Length on Main Span	No	No
Displacement Based Load Changes	None	None
Analyze Ground Line Only	No	No
Analyze with Buckling Case	No	No
Analyze with Deflection Case	No	No
Analyze with Strength Results	No	No
Custom	No	No

**Analysis Results**

**Loading**

Component	Heavy Grade C (Governing Case)			Extreme Wind			Client File Maximum Rating
	Max %	Load (Applied / Allowable)	Wind Direction	Max %	Load (Applied / Allowable)	Wind Direction	
Pole - Stress	38.32 from stress	2606 lb/in² / 6800 lb/in²	21 °	29.2 from stress	1752 lb/in² / 6000 lb/in²	77 °	8000 lb/in²
Wood 8 Ft Double 4 x 5 (SYP) [29' 0"] (CrossArm#1) - Stress	12.43	-782 lb/in² / 6290 lb/in²	148 °	3.12	-173 lb/in² / 5550 lb/in²	80 °	7400 lb/in²
24.9 kV Pin Type Insulator (Crossarm) [0' 8"] (Insulator#1) - Force	15.47	1547 lbf / 10000 lbf	163 °	3.48	348 lbf / 10000 lbf	165 °	5000 lbf
24.9 kV Pin Type Insulator (Crossarm) [7' 4"] (Insulator#2) - Force	15.46	1546 lbf / 10000 lbf	163 °	3.49	349 lbf / 10000 lbf	164 °	5000 lbf
24.9 kV Pin Type Insulator (Crossarm) [3' 4"] (Insulator#3) - Force	15.52	1552 lbf / 10000 lbf	163 °	3.52	352 lbf / 10000 lbf	165 °	5000 lbf
3" Spool Bolt [25' 2"] (Insulator#4) - Force	41.14	1234 lbf / 3000 lbf	163 °	7.29	219 lbf / 3000 lbf	164 °	3000 lbf
Comm 3 Bolt Clamp [21' 0"] (Insulator#5) - Force	69.57	2087 lbf / 3000 lbf	163 °	18.22	547 lbf / 3000 lbf	187 °	3000 lbf
1/4" EHS, Full (ProposedWire#2) - Tension	30.27	2013 lbf / 3990 lbf	N/A	N/A	N/A	N/A	6650 lbf
1/0 ACSR, Full (Wire#1) - Tension	47.9	2098 lbf / 2628 lbf	N/A	N/A	N/A	N/A	4380 lbf
3/8" EHS [28' 1"] (SpanGuy#1) - Force	35.56	4928 lbf / 13860 lbf	161 °	6.11	847 lbf / 13860 lbf	194 °	15400 lbf

Pole Analysis Charts for Governing Load Case: Heavy Grade C

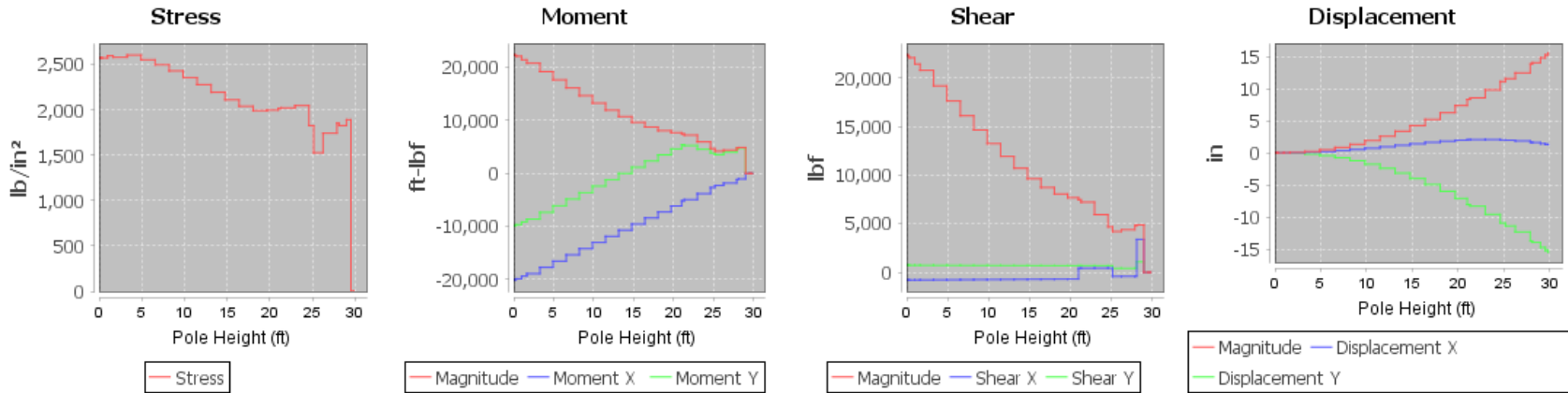

Pole Static Analysis

Heavy Grade C

Heights	Stress %	Stress (lb/in <sup>2</sup> )	Moment (ft-lbf)			Force (lbf)				Displacement (in)		
			X	Y	Magnitude	X	Y	Shear Magnitude	Axial	X	Y	Magnitude
0' 0"	37.8	2571	-20109	-9917	22422	-790	729	1075	3384	0	0	0
0' 1"	37.91	2578	-20061	-9866	22356	-789	729	1074	3380	0	0	0
0' 2"	37.91	2578	-19966	-9762	22225	-788	729	1074	3375	0	0	0
0' 4"	37.86	2574	-19870	-9659	22093	-786	728	1071	3358	0	0	0
1' 0"	38.19	2597	-19393	-9143	21440	-782	727	1068	3331	0	0	0
1' 8"	37.96	2581	-18916	-8629	20791	-776	724	1062	3284	0	0	0
3' 3"	38.32	2606	-17728	-7356	19194	-767	721	1053	3220	0	0	0
4' 11"	37.57	2554	-16546	-6097	17633	-759	717	1044	3158	0	0	0
6' 7"	36.75	2499	-15369	-4853	16117	-750	714	1036	3098	0	-1	1
8' 2"	35.76	2432	-14197	-3622	14652	-742	711	1028	3041	1	-1	1
9' 10"	34.66	2357	-13031	-2405	13251	-734	708	1020	2986	1	-2	2
11' 6"	33.53	2280	-11870	-1201	11930	-726	705	1012	2934	1	-2	3
13' 1"	32.29	2195	-10714	-10	10714	-718	702	1004	2884	1	-3	3
14' 9"	31.06	2112	-9562	1168	9633	-711	699	997	2836	1	-4	4
16' 5"	30.02	2041	-8416	2333	8733	-703	696	989	2790	2	-5	5
18' 1"	29.3	1993	-7274	3487	8066	-696	693	982	2747	2	-6	6
19' 8"	29.39	1999	-6137	4628	7686	-690	691	976	2709	2	-7	7
21' 0"	29.67	2017	-5181	5389	7475	422	697	815	1920	2	-8	8
21' 4"	29.75	2023	-4954	5251	7219	426	696	816	1897	2	-8	9
23' 0"	30.12	2048	-3812	4553	5938	433	693	817	1859	2	-10	10
24' 7"	26.87	1827	-2675	3843	4683	437	692	818	1835	2	-11	11
25' 2"	22.47	1528	-2270	3537	4203	-419	412	588	1608	2	-11	12
26' 3"	25.65	1744	-1825	3990	4388	-414	410	583	1581	2	-12	12
27' 11"	27.27	1855	-1151	4670	4810	-411	409	580	1562	2	-14	14
28' 1"	26.88	1828	-1055	4769	4885	3391	1077	3558	1004	2	-14	14
29' 0"	27.84	1893	0	-1	1	-2	1	2	10	1	-15	15
29' 6"	0.01	1	0	0	0	-1	0	1	3	1	-15	15
29' 10"	0	0	0	0	0	0	0	0	0	1	-15	16

Extreme Wind

Heights	Stress %	Stress (lb/in <sup>2</sup> )	Moment (ft-lbf)			Force (lbf)				Displacement (in)		
			X	Y	Magnitude	X	Y	Shear Magnitude	Axial	X	Y	Magnitude
0' 0"	29	1740	-12957	-8205	15336	-650	612	893	897	0	0	0
0' 1"	29.1	1746	-12917	-8162	15280	-649	611	891	894	0	0	0
0' 2"	29.08	1745	-12837	-8077	15166	-649	608	889	892	0	0	0
0' 4"	28.99	1740	-12757	-7992	15053	-647	602	884	883	0	0	0
1' 0"	29.2	1752	-12362	-7567	14494	-645	592	875	868	0	0	0
1' 8"	28.79	1728	-11973	-7144	13942	-641	574	860	844	0	0	0
3' 3"	28.84	1730	-11031	-6092	12602	-635	549	840	810	0	0	0
4' 11"	27.66	1660	-10131	-5051	11320	-629	525	819	777	0	0	0
6' 7"	26.45	1587	-9270	-4018	10103	-624	501	800	746	0	0	1
8' 2"	25.12	1507	-8449	-2995	8964	-618	477	781	716	0	-1	1
9' 10"	23.74	1425	-7666	-1980	7918	-613	454	763	687	1	-1	1
11' 6"	22.42	1345	-6922	-975	6990	-608	431	745	660	1	-1	2
13' 1"	21.15	1269	-6214	23	6214	-603	409	729	633	1	-2	2
14' 9"	20.12	1207	-5542	1012	5634	-598	388	713	608	1	-2	3
16' 5"	19.58	1175	-4906	1992	5295	-593	367	697	584	1	-3	3
18' 1"	21.76	1306	-4304	2965	5227	-588	346	683	561	1	-4	4
19' 8"	24.61	1477	-3736	3930	5422	-584	328	670	541	2	-4	5
21' 0"	24.43	1466	-3299	4685	5729	541	462	711	371	2	-5	5
21' 4"	25.45	1527	-3148	4509	5499	544	450	706	359	2	-5	5
23' 0"	25.6	1536	-2409	3617	4346	548	431	697	339	2	-6	6
24' 7"	21.89	1314	-1702	2718	3206	551	419	692	326	2	-7	7
25' 2"	17.06	1024	-1466	2404	2816	345	350	491	302	2	-7	7
26' 3"	15.62	937	-1087	2032	2305	348	336	483	287	2	-7	8
27' 11"	13.73	824	-537	1461	1557	350	325	478	277	1	-8	8
28' 1"	9.76	585	-460	1380	1454	959	427	1050	181	1	-8	9
29' 0"	9.34	561	-4	-1	4	-1	6	6	5	1	-9	9
29' 6"	0.03	2	0	0	0	0	2	2	1	1	-9	9
29' 10"	0	0	0	0	0	0	0	0	0	1	-9	9



Measured: Proposed

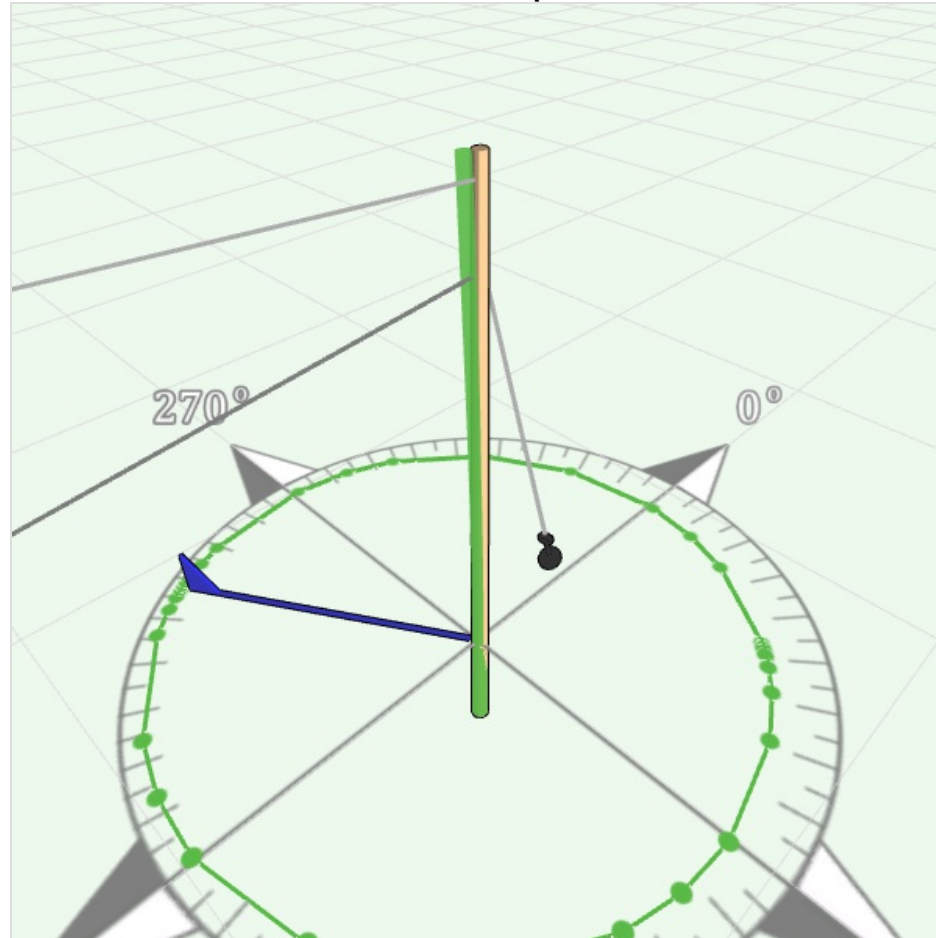

**Design Properties**

**Owner:** Unset Com Owner  
**Species:** Southern Pine  
**Length:** 30'  
**Class:** 4  
**AGL:** 24' 1"  
**GLC:** 30 1/4"  
**Foundation:** None  
**Ground Water Level:** None  
**Lean Angle:** 0 °  
**Lean Direction:** 0 °  
**Capacity Adjustment:** 100%  
**Effective Allowable Stress:** 8000 lb/in<sup>2</sup>  
**GPS Location:** 38.94327052610672 , -91.20885445695919  
**Map Location:** 38.94326508972015 , -91.20884199002715

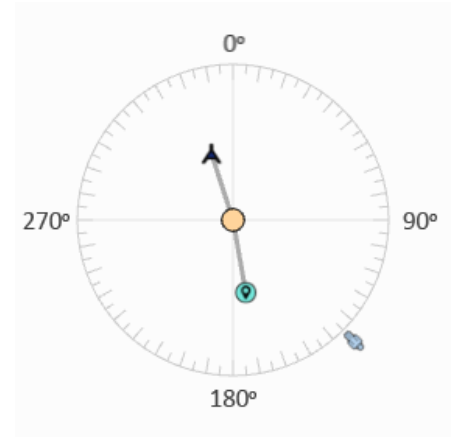
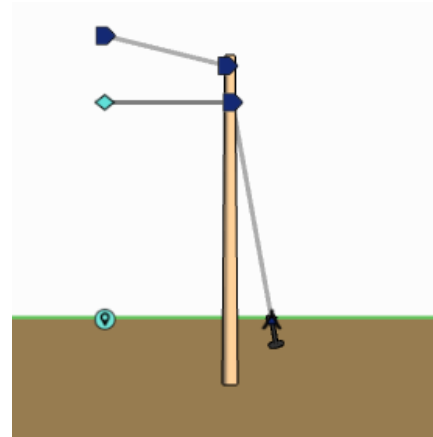

**Load Case Properties**

	Heavy Grade C (Governing Case)	Extreme Wind
LoadCase Type	NESC 2012 Heavy	NESC Extreme Wind 2012
Construction Grade	C	B
Construction Type	New	New
Temperature	0 °F	60 °F
Wind Pressure	4 lb/ft <sup>2</sup>	90 mph
Ice Thickness	0.5"	0"
Wind	Sweep	Sweep
Wind Direction	0 °	0 °
Wind Increment	1 °	1 °
Analysis Method	Basic (Direct Stiffness)	Basic (Direct Stiffness)
Load Percentage Allowed	100%	100%
Average Length on Main Span	No	No
Displacement Based Load Changes	None	None
Analyze Ground Line Only	No	No
Analyze with Buckling Case	No	No
Analyze with Deflection Case	No	No
Analyze with Strength Results	No	No
Custom	No	No

**Analysis Results**

**Loading**

Component	Heavy Grade C (Governing Case)			Extreme Wind			Client File Maximum Rating
	Max %	Load (Applied / Allowable)	Wind Direction	Max %	Load (Applied / Allowable)	Wind Direction	
Pole - Stress	29.3 from stress	1992 lb/in <sup>2</sup> / 6800 lb/in <sup>2</sup>	238 °	25.5 from stress	1530 lb/in <sup>2</sup> / 6000 lb/in <sup>2</sup>	234 °	8000 lb/in <sup>2</sup>
1/4" EHS, Full (ProposedWire#1) - Tension	30.27	2013 lbf / 3990 lbf	N/A	N/A	N/A	N/A	6650 lbf
1/4" EHS [19' 10"] (DownGuy#1) - Force	75.66	4528 lbf / 5985 lbf	157 °	60.48	3620 lbf / 5985 lbf	162 °	6650 lbf
Proposed Anchor [8' 0", 342 °] (Anchor#1) - Force	64.69	4528 lbf / 7000 lbf	157 °	51.71	3620 lbf / 7000 lbf	162 °	7000 lbf
3/8" EHS [23' 2"] (SpanGuy#1) - Force	0	0 lbf / 13860 lbf	0 °	0	0 lbf / 13860 lbf	0 °	15400 lbf

Pole Analysis Charts for Governing Load Case: Heavy Grade C

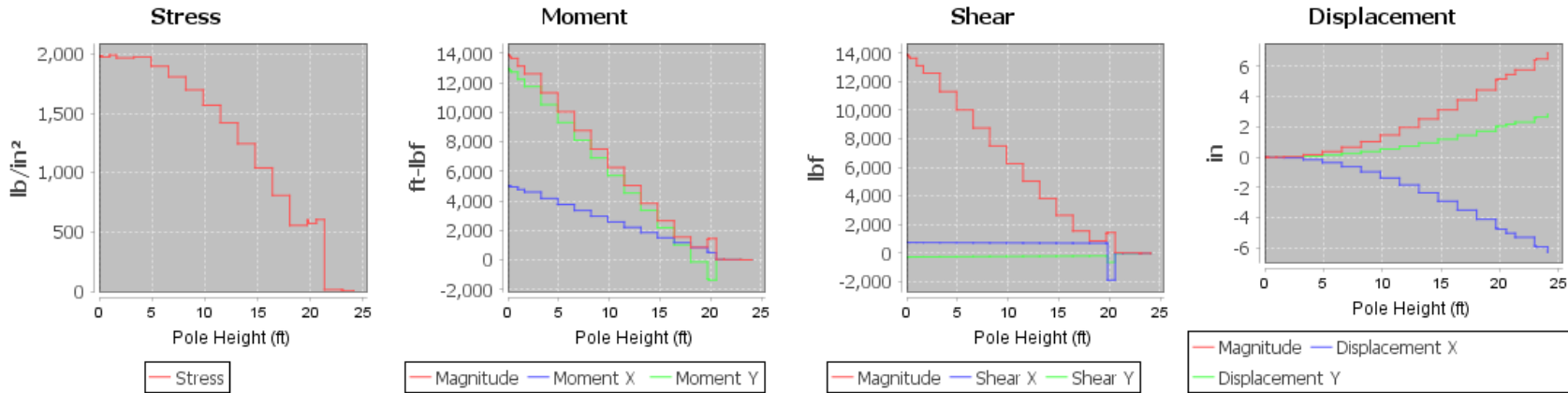

Pole Static Analysis

Heavy Grade C

Heights	Stress %	Stress (lb/in <sup>2</sup> )	Moment (ft-lbf)			Force (lbf)					Displacement (in)		
			X	Y	Magnitude	X	Y	Shear Magnitude	Axial	X	Y	Magnitude	
0' 0"	29.04	1975	5032	12966	13908	751	-272	799	5418	0	0	0	
0' 1"	29.14	1982	5014	12917	13856	751	-271	798	5415	0	0	0	
0' 2"	29.13	1981	4978	12819	13751	750	-271	798	5410	0	0	0	
0' 4"	29.05	1976	4943	12720	13647	749	-269	796	5395	0	0	0	
1' 0"	29.3	1992	4767	12229	13125	747	-266	793	5371	0	0	0	
1' 8"	28.94	1968	4592	11738	12605	744	-260	788	5331	0	0	0	
3' 3"	29.06	1976	4165	10518	11313	739	-253	781	5274	0	0	0	
4' 11"	27.91	1898	3750	9306	10033	735	-246	775	5220	0	0	0	
6' 7"	26.59	1808	3347	8101	8765	730	-238	768	5168	-1	0	1	
8' 2"	24.97	1698	2956	6903	7509	726	-231	762	5119	-1	0	1	
9' 10"	23.08	1569	2577	5713	6267	721	-225	756	5072	-1	1	1	
11' 6"	20.9	1421	2208	4529	5039	717	-218	750	5027	-2	1	2	
13' 1"	18.3	1245	1851	3352	3829	713	-211	744	4984	-2	1	3	
14' 9"	15.3	1040	1504	2182	2650	709	-205	738	4944	-3	1	3	
16' 5"	11.89	809	1167	1019	1550	705	-199	733	4905	-3	1	4	
18' 1"	8.17	556	841	-138	853	702	-193	728	4869	-4	2	4	
19' 8"	8.82	600	525	-1289	1392	700	-190	725	4849	-5	2	5	
19' 10"	8.41	572	491	-1361	1447	-1878	-631	1981	4948	-5	2	5	
20' 7"	8.9	605	28	20	35	9	-14	16	69	-5	2	5	
21' 4"	0.2	14	18	14	23	6	-9	11	46	-5	2	6	
23' 0"	0.14	10	2	4	5	4	-6	8	28	-6	3	6	
23' 2"	0.04	3	2	1	2	1	-2	2	9	-6	3	6	
24' 1"	0.01	1	0	0	0	0	0	0	0	-6	3	7	

**Extreme Wind**

Heights	Stress %	Stress (lb/in <sup>2</sup> )	Moment (ft-lbf)			Force (lbf)				Displacement (in)		
			X	Y	Magnitude	X	Y	Shear Magnitude	Axial	X	Y	Magnitude
0' 0"	25.32	1519	5416	9318	10777	594	-366	698	3459	0	0	0
0' 1"	25.42	1525	5392	9279	10732	594	-365	697	3457	0	0	0
0' 2"	25.4	1524	5344	9201	10640	592	-363	695	3454	0	0	0
0' 4"	25.31	1519	5296	9123	10549	589	-358	689	3447	0	0	0
1' 0"	25.5	1530	5061	8737	10097	583	-350	680	3434	0	0	0
1' 8"	25.06	1504	4831	8354	9651	573	-336	664	3413	0	0	0
3' 3"	25.05	1503	4279	7414	8561	559	-317	643	3383	0	0	0
4' 11"	23.78	1427	3759	6498	7507	545	-298	621	3354	0	0	0
6' 7"	22.4	1344	3270	5603	6488	532	-279	601	3327	0	0	1
8' 2"	20.81	1249	2812	4731	5504	518	-261	581	3301	-1	0	1
9' 10"	19.04	1142	2383	3881	4554	505	-244	561	3277	-1	1	1
11' 6"	17.09	1025	1984	3052	3640	493	-226	542	3253	-1	1	1
13' 1"	14.86	892	1612	2243	2763	481	-209	524	3230	-2	1	2
14' 9"	12.39	743	1269	1455	1931	469	-193	507	3209	-2	1	2
16' 5"	9.68	581	953	686	1174	457	-177	490	3189	-2	1	3
18' 1"	6.82	409	663	-64	666	446	-161	474	3170	-3	2	3
19' 8"	6.38	383	398	-795	889	440	-153	465	3159	-3	2	4
19' 10"	6.11	367	373	-844	923	-1201	-437	1278	3208	-3	2	4
20' 7"	6.45	387	54	41	68	20	-28	34	36	-3	2	4
21' 4"	0.41	24	33	25	42	12	-17	21	24	-4	2	4
23' 0"	0.27	16	5	5	7	7	-9	11	15	-4	3	5
23' 2"	0.05	3	4	3	5	3	-4	5	5	-4	3	5
24' 1"	0.03	2	0	0	0	0	0	0	0	-4	3	5

Measured: Proposed

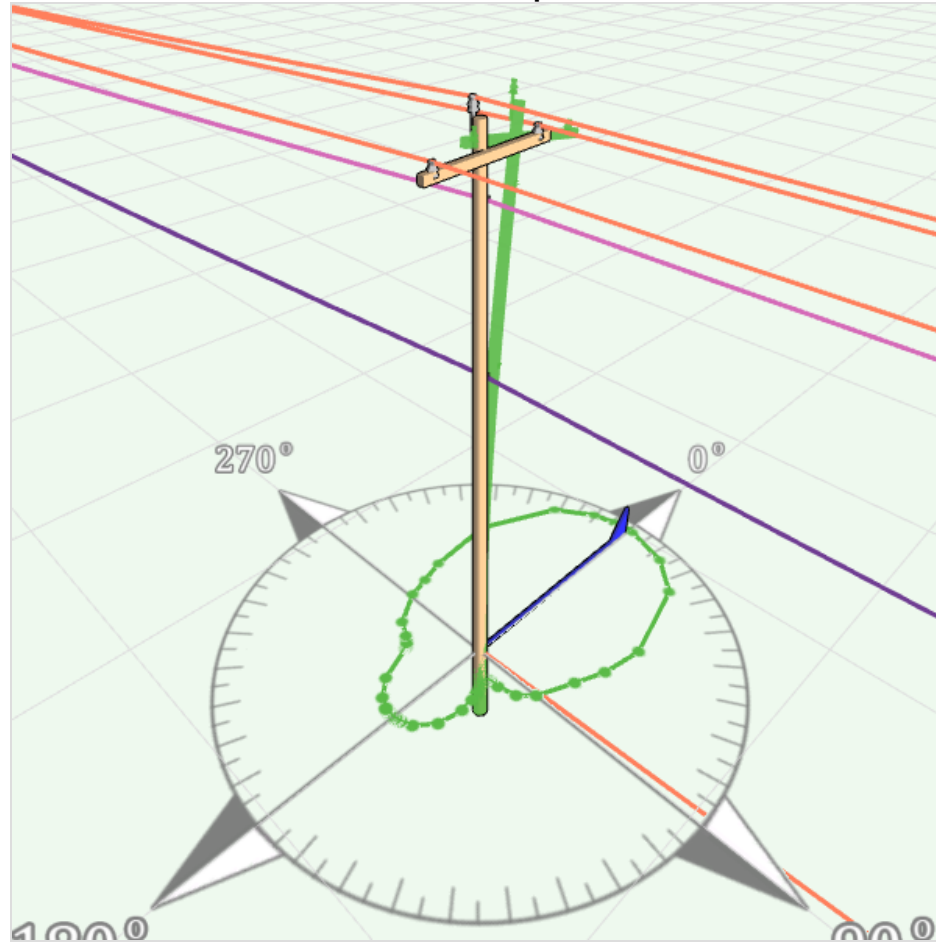

**Design Properties**

Owner: Unset Com Owner  
 Species: Southern Pine  
 Length: 40'  
 Class: 4  
 AGL: 33' 5"  
 GLC: 33 1/4"  
 Foundation: None  
 Ground Water Level: None  
 Lean Angle: 0 °  
 Lean Direction: 0 °  
 Capacity Adjustment: 100%  
 Effective Allowable Stress: 8000 lb/in²  
 GPS Location: 38.94318801348227 , -91.20801215178345  
 Map Location: 38.943181424617165 , -91.20800036478086

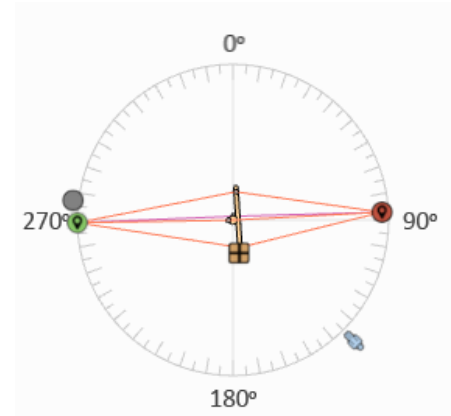
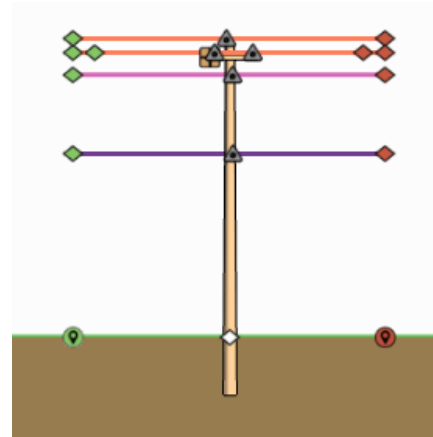

**Load Case Properties**

	Heavy Grade C (Governing Case)	Extreme Wind
LoadCase Type	NESC 2012 Heavy	NESC Extreme Wind 2012
Construction Grade	C	B
Construction Type	New	New
Temperature	0 °F	60 °F
Wind Pressure	4 lb/ft²	90 mph
Ice Thickness	0.5"	0"
Wind	Sweep	Sweep
Wind Direction	0 °	0 °
Wind Increment	1 °	1 °
Analysis Method	Basic (Direct Stiffness)	Basic (Direct Stiffness)
Load Percentage Allowed	100%	100%
Average Length on Main Span	No	No
Displacement Based Load Changes	None	None
Analyze Ground Line Only	No	No
Analyze with Buckling Case	No	No
Analyze with Deflection Case	No	No
Analyze with Strength Results	No	No
Custom	No	No

**Analysis Results**

**Loading**

Component	Heavy Grade C (Governing Case)			Extreme Wind			Client File Maximum Rating
	Max %	Load (Applied / Allowable)	Wind Direction	Max %	Load (Applied / Allowable)	Wind Direction	
Pole - Stress	73.9 from stress	5025 lb/in² / 6800 lb/in²	359 °	28.8 from stress	1728 lb/in² / 6000 lb/in²	289 °	8000 lb/in²
Wood 8 Ft 4 x 5 (SYP) [32' 0"] (CrossArm#1) - Stress	16.64	-1047 lb/in² / 6290 lb/in²	0 °	3.37	-187 lb/in² / 5550 lb/in²	84 °	7400 lb/in²
24.9 kV Pin Type Insulator (Crossarm) [0' 8"] (Insulator#1) - Force	9.1	455 lbf / 5000 lbf	358 °	1	50 lbf / 5000 lbf	358 °	5000 lbf
24.9 kV Pin Type Insulator (Crossarm) [7' 4"] (Insulator#2) - Force	9.1	455 lbf / 5000 lbf	358 °	1	50 lbf / 5000 lbf	358 °	5000 lbf
3" Spool Bolt [30' 0"] (Insulator#3) - Force	13.87	416 lbf / 3000 lbf	358 °	1.26	38 lbf / 3000 lbf	358 °	3000 lbf
24.9 kV Pin Type Insulator (Pole Top) [32' 7"] (Insulator#4) - Force	9.62	481 lbf / 5000 lbf	358 °	1.12	56 lbf / 5000 lbf	358 °	5000 lbf
Comm 3 Bolt Clamp [21' 0"] (Insulator#7) - Force	25.18	755 lbf / 3000 lbf	359 °	7.28	219 lbf / 3000 lbf	297 °	3000 lbf
Proposed Fiber 1", Full (ProposedWire#1) - Tension	23.96	2684 lbf / 6720 lbf	N/A	N/A	N/A	N/A	11200 lbf
1/0 ACSR, Full (Wire#3) - Tension	46.83	2051 lbf / 2628 lbf	N/A	N/A	N/A	N/A	4380 lbf

Pole Analysis Charts for Governing Load Case: Heavy Grade C

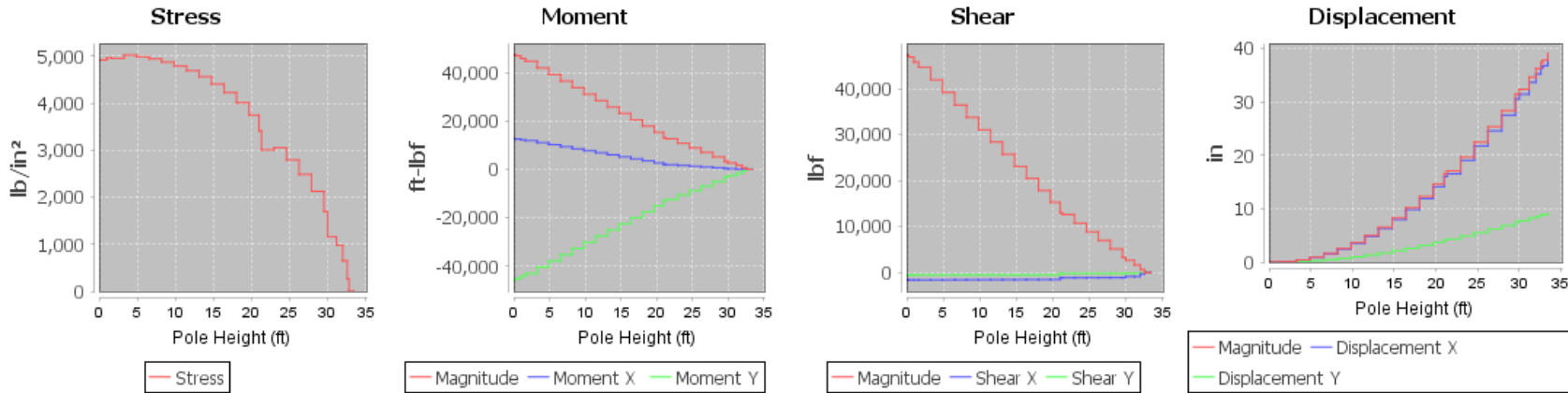

Pole Static Analysis

Heavy Grade C

Heights	Stress %	Stress (lb/in <sup>2</sup> )	Moment (ft-lbf)			Force (lbf)				Displacement (in)		
			X	Y	Magnitude	X	Y	Shear Magnitude	Axial	X	Y	Magnitude
0' 0"	72.19	4909	12694	-45727	47456	-1615	-510	1694	3130	0	0	0
0' 1"	72.36	4921	12661	-45621	47345	-1614	-510	1693	3125	0	0	0
0' 2"	72.39	4923	12594	-45409	47123	-1614	-510	1692	3119	0	0	0
0' 4"	72.35	4920	12527	-45197	46901	-1611	-510	1690	3102	0	0	0
1' 0"	73.01	4965	12192	-44140	45793	-1607	-510	1686	3073	0	0	0
1' 8"	72.9	4957	11857	-43086	44688	-1600	-510	1679	3023	0	0	0
3' 3"	73.9	5025	11021	-40461	41935	-1590	-510	1670	2954	0	0	0
4' 11"	73.34	4987	10185	-37852	39198	-1581	-510	1661	2887	1	0	1
6' 7"	72.69	4943	9349	-35259	36477	-1571	-509	1652	2823	2	0	2
8' 2"	71.71	4876	8513	-32681	33771	-1562	-509	1643	2762	2	1	3
9' 10"	70.46	4791	7678	-30118	31081	-1553	-509	1634	2703	4	1	4
11' 6"	69.01	4693	6843	-27570	28407	-1544	-509	1626	2646	5	1	5
13' 1"	67.11	4564	6008	-25037	25747	-1536	-509	1618	2591	6	2	7
14' 9"	64.81	4407	5173	-22518	23104	-1527	-509	1610	2539	8	2	8
16' 5"	62.17	4227	4339	-20012	20477	-1519	-508	1602	2489	10	3	10
18' 1"	58.99	4011	3505	-17521	17868	-1511	-508	1594	2442	12	3	12
19' 8"	55.11	3748	2671	-15043	15278	-1504	-508	1587	2400	14	4	15
21' 0"	50.2	3413	2006	-12866	13021	-1143	-197	1160	1790	16	4	17
21' 4"	44.26	3010	1942	-12494	12644	-1138	-197	1155	1764	17	4	17
23' 0"	44.89	3053	1619	-10627	10749	-1131	-197	1148	1723	19	5	20
24' 7"	41.08	2793	1297	-8772	8867	-1123	-196	1140	1683	22	6	22
26' 3"	36.56	2486	974	-6929	6998	-1116	-196	1133	1646	25	6	25
27' 11"	31.28	2127	652	-5099	5140	-1109	-196	1126	1610	28	7	28
29' 6"	24.97	1698	330	-3279	3296	-1105	-196	1122	1588	31	8	31
30' 0"	17.05	1159	239	-2658	2669	-859	-150	872	1236	31	8	32
31' 2"	14.36	977	64	-1655	1656	-855	-150	868	1216	34	8	35
32' 0"	9.55	649	244	-615	662	-292	-48	296	405	35	9	36
32' 7"	3.92	267	0	-1	1	-3	0	3	13	36	9	37
32' 10"	0.01	1	0	-1	1	-1	0	1	6	37	9	38
33' 5"	0.01	0	0	0	0	0	0	0	0	38	9	39

**Extreme Wind**

Heights	Stress %	Stress (lb/in <sup>2</sup> )	Moment (ft-lbf)			Force (lbf)				Displacement (in)		
			X	Y	Magnitude	X	Y	Shear Magnitude	Axial	X	Y	Magnitude
0' 0"	28.58	1715	14996	-7171	16622	-310	-772	832	847	0	0	0
0' 1"	28.68	1721	14945	-7150	16568	-310	-771	831	844	0	0	0
0' 2"	28.66	1720	14844	-7110	16459	-309	-769	828	841	0	0	0
0' 4"	28.59	1716	14743	-7069	16350	-307	-762	821	832	0	0	0
1' 0"	28.8	1728	14243	-6868	15812	-303	-751	810	817	0	0	0
1' 8"	28.48	1709	13750	-6669	15282	-297	-732	790	791	0	0	0
3' 3"	28.59	1716	12549	-6183	13989	-287	-706	762	754	0	0	0
4' 11"	27.68	1661	11391	-5711	12743	-278	-680	734	719	0	0	0
6' 7"	26.74	1604	10276	-5254	11542	-270	-654	708	685	0	0	1
8' 2"	25.67	1540	9203	-4812	10385	-261	-629	681	653	0	1	1
9' 10"	24.51	1471	8172	-4384	9273	-253	-605	655	622	1	1	1
11' 6"	23.29	1397	7180	-3969	8204	-244	-580	630	592	1	1	2
13' 1"	21.92	1315	6228	-3569	7178	-236	-557	605	563	1	2	2
14' 9"	20.44	1226	5314	-3181	6194	-228	-534	581	536	1	2	3
16' 5"	18.85	1131	4439	-2807	5251	-220	-511	557	510	1	3	3
18' 1"	17.11	1026	3600	-2445	4352	-213	-489	534	485	2	3	4
19' 8"	15.18	911	2797	-2096	3495	-206	-470	513	463	2	4	5
21' 0"	12.99	779	2180	-1792	2822	-178	-265	319	354	2	5	5
21' 4"	10.86	652	2094	-1734	2719	-174	-252	306	341	2	5	5
23' 0"	10.93	656	1680	-1448	2218	-167	-232	286	319	3	5	6
24' 7"	9.59	576	1300	-1174	1752	-160	-212	265	298	3	6	7
26' 3"	8.17	490	953	-911	1319	-153	-192	246	279	4	7	8
27' 11"	6.67	400	638	-660	918	-147	-173	227	260	4	7	9
29' 6"	5.04	303	354	-419	549	-143	-161	215	248	4	8	9
30' 0"	3.21	193	279	-341	441	-125	-150	195	205	5	8	10
31' 2"	2.69	161	103	-195	221	-121	-139	184	195	5	9	10
32' 0"	1.46	87	42	-63	76	-33	-22	40	59	5	9	11
32' 7"	0.51	31	4	-1	4	-3	-8	8	7	5	10	11
32' 10"	0.03	2	2	-1	2	-1	-3	3	3	5	10	11
33' 5"	0.02	1	0	0	0	0	0	0	0	6	10	11



Measured: Proposed

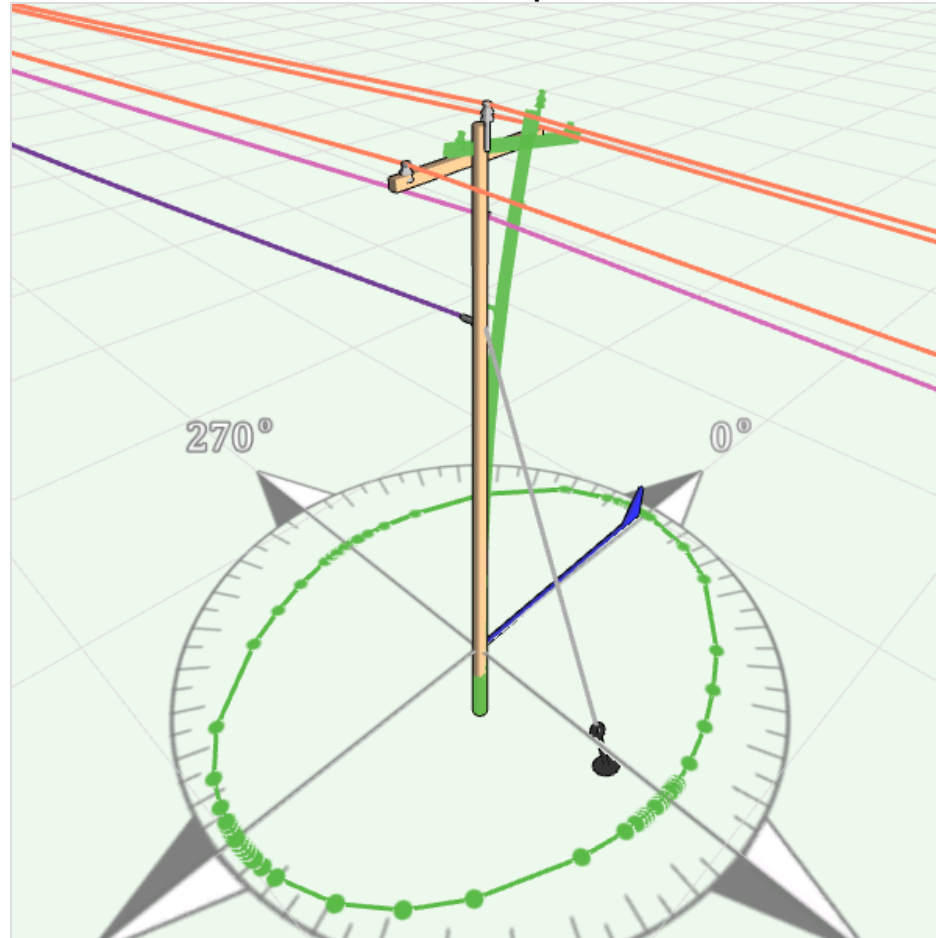

**Design Properties**

**Owner:** Unset Com Owner  
**Species:** Southern Pine  
**Length:** 35'  
**Class:** 5  
**AGL:** 29' 0"  
**GLC:** 29"  
**Foundation:** None  
**Ground Water Level:** None  
**Lean Angle:** 0 °  
**Lean Direction:** 0 °  
**Capacity Adjustment:** 100%  
**Effective Allowable Stress:** 8000 lb/in<sup>2</sup>  
**GPS Location:** Undefined.  
**Map Location:** 38.94321340449738 , -91.2072157329112

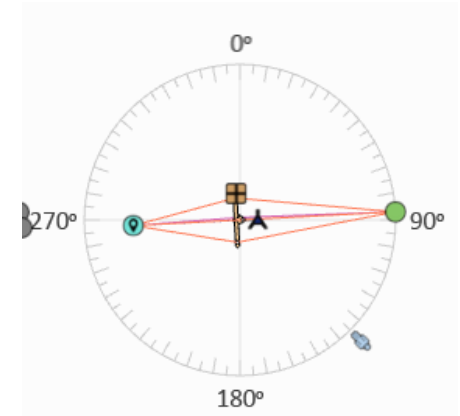
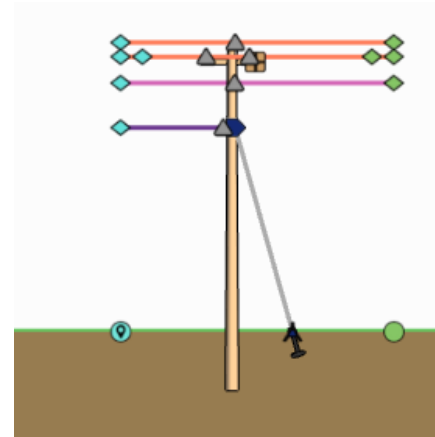

**Load Case Properties**

	Heavy Grade C (Governing Case)	Extreme Wind
LoadCase Type	NESC 2012 Heavy	NESC Extreme Wind 2012
Construction Grade	C	B
Construction Type	New	New
Temperature	0 °F	60 °F
Wind Pressure	4 lb/ft <sup>2</sup>	90 mph
Ice Thickness	0.5"	0"
Wind	Sweep	Sweep
Wind Direction	0 °	0 °
Wind Increment	1 °	1 °
Analysis Method	Basic (Direct Stiffness)	Basic (Direct Stiffness)
Load Percentage Allowed	100%	100%
Average Length on Main Span	No	No
Displacement Based Load Changes	None	None
Analyze Ground Line Only	No	No
Analyze with Buckling Case	No	No
Analyze with Deflection Case	No	No
Analyze with Strength Results	No	No
Custom	No	No

**Analysis Results**

**Loading**

Component	Heavy Grade C (Governing Case)			Extreme Wind			Client File Maximum Rating
	Max %	Load (Applied / Allowable)	Wind Direction	Max %	Load (Applied / Allowable)	Wind Direction	
Pole - Stress	73.42 from stress	4993 lb/in <sup>2</sup> / 6800 lb/in <sup>2</sup>	358 °	19.86 from stress	1192 lb/in <sup>2</sup> / 6000 lb/in <sup>2</sup>	328 °	8000 lb/in <sup>2</sup>
Wood 8 Ft 4 x 5 (SYP) [27' 9"] (CrossArm#1) - Stress	25.77	-1621 lb/in <sup>2</sup> / 6290 lb/in <sup>2</sup>	176 °	3.13	-174 lb/in <sup>2</sup> / 5550 lb/in <sup>2</sup>	271 °	7400 lb/in <sup>2</sup>
24.9 kV Pin Type Insulator (Crossarm) [0' 8"] (Insulator#1) - Force	11.92	596 lbf / 5000 lbf	177 °	0.81	40 lbf / 5000 lbf	35 °	5000 lbf
24.9 kV Pin Type Insulator (Crossarm) [7' 4"] (Insulator#2) - Force	11.92	596 lbf / 5000 lbf	177 °	0.81	40 lbf / 5000 lbf	327 °	5000 lbf
3" Spool Bolt [25' 7"] (Insulator#3) - Force	17.92	538 lbf / 3000 lbf	177 °	1.01	30 lbf / 3000 lbf	165 °	3000 lbf
24.9 kV Pin Type Insulator (Pole Top) [28' 2"] (Insulator#4) - Force	11.93	596 lbf / 5000 lbf	177 °	0.81	41 lbf / 5000 lbf	46 °	5000 lbf
Comm D/E Bolt [21' 0"] (Insulator#5) - Force	45.65	3196 lbf / 7000 lbf	357 °	12.7	889 lbf / 7000 lbf	312 °	7000 lbf
Proposed Fiber 1", Full (ProposedWire#1) - Tension	21.91	2454 lbf / 6720 lbf	N/A	N/A	N/A	N/A	11200 lbf
1/0 ACSR, Full (Wire#8) - Tension	53.32	2335 lbf / 2628 lbf	N/A	N/A	N/A	N/A	4380 lbf
1/4" EHS [21' 0"] (DownGuy#1) - Force	31.08	1860 lbf / 5985 lbf	267 °	47.69	2854 lbf / 5985 lbf	267 °	6650 lbf
Proposed Anchor [8' 0", 87 °] (Anchor#1) - Force	26.57	1860 lbf / 7000 lbf	267 °	40.78	2854 lbf / 7000 lbf	267 °	7000 lbf

### Pole Analysis Charts for Governing Load Case: Heavy Grade C

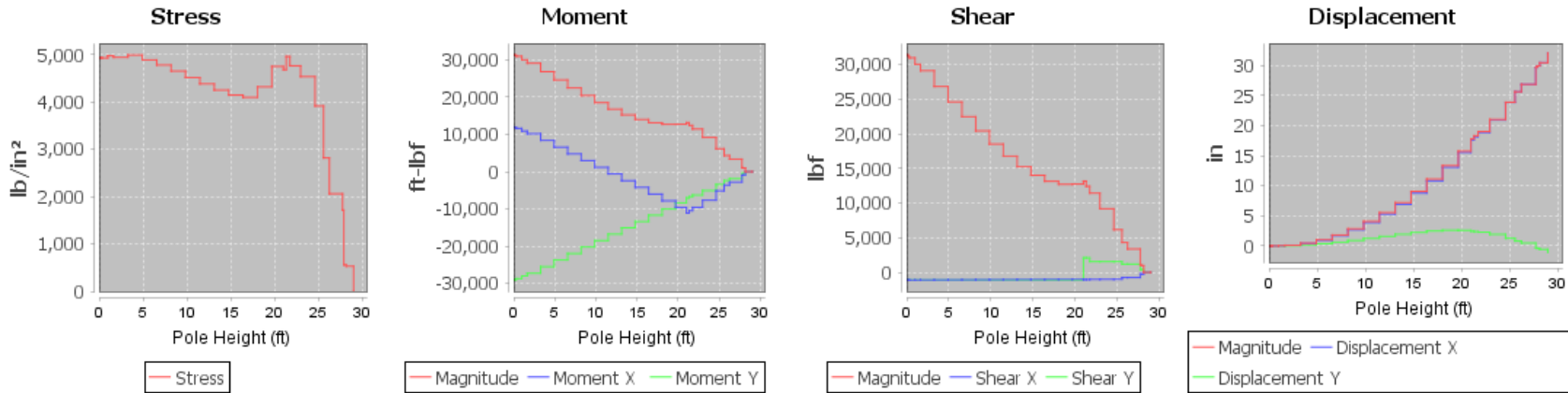

### Pole Static Analysis

#### Heavy Grade C

Heights	Stress %	Stress (lb/in <sup>2</sup> )	Moment (ft-lbf)			Force (lbf)				Displacement (in)		
			X	Y	Magnitude	X	Y	Shear Magnitude	Axial	X	Y	Magnitude
0' 0"	72.41	4924	11991	-29054	31431	-1100	-1099	1555	3885	0	0	0
0' 1"	72.63	4939	11919	-28982	31337	-1099	-1099	1554	3882	0	0	0
0' 2"	72.63	4939	11775	-28838	31149	-1099	-1099	1554	3878	0	0	0
0' 4"	72.52	4931	11631	-28693	30961	-1097	-1099	1552	3864	0	0	0
1' 0"	73.16	4975	10910	-27974	30026	-1093	-1098	1550	3842	0	0	0
1' 8"	72.7	4944	10189	-27257	29099	-1087	-1098	1545	3804	0	0	0
3' 3"	73.42	4993	8388	-25473	26819	-1079	-1098	1539	3752	0	0	0
4' 11"	71.92	4891	6586	-23704	24602	-1070	-1098	1533	3702	1	0	1
6' 7"	70.33	4783	4786	-21948	22464	-1062	-1097	1527	3654	2	1	2
8' 2"	68.45	4654	2986	-20206	20425	-1054	-1097	1522	3608	3	1	3
9' 10"	66.43	4517	1186	-18476	18514	-1046	-1097	1516	3564	4	1	4
11' 6"	64.48	4384	-613	-16760	16771	-1039	-1097	1510	3522	5	2	6
13' 1"	62.53	4252	-2412	-15056	15248	-1031	-1096	1505	3481	7	2	7
14' 9"	60.97	4146	-4211	-13364	14012	-1024	-1096	1500	3443	9	2	9
16' 5"	60.28	4099	-6009	-11684	13139	-1017	-1096	1495	3406	11	2	11
18' 1"	63.54	4321	-7806	-10016	12699	-1010	-1096	1490	3371	13	3	13
19' 8"	69.87	4751	-9604	-8359	12732	-1004	-1095	1486	3341	16	3	16
21' 0"	68.85	4682	-11128	-7043	13169	-1032	2087	2328	3035	18	2	18
21' 4"	72.95	4961	-10448	-6708	12416	-1031	2087	2328	3028	18	2	18
21' 9"	70.08	4766	-9564	-6272	11437	-998	1555	1848	1628	19	2	19
23' 0"	66.73	4537	-7671	-5058	9189	-992	1555	1845	1602	21	2	21
24' 7"	57.59	3916	-5120	-3430	6163	-987	1555	1842	1579	24	1	24
25' 7"	41.44	2818	-3599	-2378	4313	-753	1196	1413	1239	26	1	26
26' 3"	30.33	2062	-2805	-1878	3376	-749	1196	1411	1222	27	0	27
27' 9"	25.23	1715	-923	-505	1052	-252	399	472	387	30	0	30
27' 11"	8.21	559	-868	-470	987	-251	399	471	384	30	0	30
28' 2"	7.81	531	0	-1	1	-1	0	1	6	30	-1	30
29' 0"	0.01	1	0	0	0	0	0	0	0	32	-1	32

**Extreme Wind**

Heights	Stress %	Stress (lb/in <sup>2</sup> )	Moment (ft-lbf)			Force (lbf)				Displacement (in)		
			X	Y	Magnitude	X	Y	Shear Magnitude	Axial	X	Y	Magnitude
0' 0"	19.75	1185	4392	-5951	7396	-366	-289	467	2758	0	0	0
0' 1"	19.83	1190	4373	-5927	7365	-365	-288	465	2757	0	0	0
0' 2"	19.81	1188	4335	-5879	7304	-364	-287	463	2754	0	0	0
0' 4"	19.73	1184	4297	-5831	7243	-359	-284	458	2747	0	0	0
1' 0"	19.86	1192	4111	-5596	6943	-351	-279	448	2736	0	0	0
1' 8"	19.53	1172	3927	-5366	6649	-337	-271	432	2716	0	0	0
3' 3"	19.5	1170	3483	-4813	5942	-317	-258	409	2688	0	0	0
4' 11"	18.57	1114	3060	-4293	5272	-298	-246	387	2662	0	0	0
6' 7"	17.62	1057	2656	-3805	4640	-279	-235	365	2637	0	0	0
8' 2"	16.58	995	2271	-3347	4044	-261	-223	343	2612	1	0	1
9' 10"	15.5	930	1905	-2919	3486	-243	-212	322	2589	1	1	1
11' 6"	14.38	863	1558	-2521	2963	-225	-201	302	2567	1	1	1
13' 1"	13.19	791	1228	-2152	2477	-208	-190	282	2546	1	1	2
14' 9"	11.93	716	916	-1811	2029	-191	-180	262	2525	2	1	2
16' 5"	10.65	639	622	-1497	1621	-175	-169	243	2506	2	1	2
18' 1"	9.34	560	344	-1211	1258	-159	-159	225	2488	2	2	3
19' 8"	8.01	481	83	-950	954	-145	-151	209	2472	3	2	3
21' 0"	6.73	404	-129	-761	772	-181	741	763	2415	3	2	4
21' 4"	5.85	351	112	-702	711	-177	743	764	2411	3	2	4
21' 9"	5.55	333	429	-630	762	-122	-76	144	254	3	2	4
23' 0"	5.11	306	336	-481	587	-110	-68	129	241	4	2	4
24' 7"	4.23	254	223	-301	375	-98	-61	115	229	4	3	5
25' 7"	2.93	176	164	-198	257	-90	-56	106	191	4	3	5
26' 3"	2.11	126	127	-138	187	-81	-50	95	182	4	3	5
27' 9"	1.65	99	-4	-17	17	-17	-11	21	50	5	3	6
27' 11"	0.18	11	-5	-14	15	-16	-10	19	48	5	3	6
28' 2"	0.16	10	2	-3	3	-3	-2	4	3	5	3	6
29' 0"	0.03	2	0	0	0	0	0	0	0	5	3	6